

CALCULUS III

Multiple Integrals

Paul Dawkins

Table of Contents

Preface	ii
Multiple Integrals	3
Introduction	3
Double Integrals	4
Iterated Integrals	8
Double Integrals Over General Regions	15
Double Integrals in Polar Coordinates	26
Triple Integrals	37
Triple Integrals in Cylindrical Coordinates	45
Triple Integrals in Spherical Coordinates	48
Change of Variables	52
Surface Area	61
Area and Volume Revisited	64

Preface

Here are my online notes for my Calculus III course that I teach here at Lamar University. Despite the fact that these are my “class notes”, they should be accessible to anyone wanting to learn Calculus III or needing a refresher in some of the topics from the class.

These notes do assume that the reader has a good working knowledge of Calculus I topics including limits, derivatives and integration. It also assumes that the reader has a good knowledge of several Calculus II topics including some integration techniques, parametric equations, vectors, and knowledge of three dimensional space.

Here are a couple of warnings to my students who may be here to get a copy of what happened on a day that you missed.

1. Because I wanted to make this a fairly complete set of notes for anyone wanting to learn calculus I have included some material that I do not usually have time to cover in class and because this changes from semester to semester it is not noted here. You will need to find one of your fellow class mates to see if there is something in these notes that wasn't covered in class.
2. In general I try to work problems in class that are different from my notes. However, with Calculus III many of the problems are difficult to make up on the spur of the moment and so in this class my class work will follow these notes fairly close as far as worked problems go. With that being said I will, on occasion, work problems off the top of my head when I can to provide more examples than just those in my notes. Also, I often don't have time in class to work all of the problems in the notes and so you will find that some sections contain problems that weren't worked in class due to time restrictions.
3. Sometimes questions in class will lead down paths that are not covered here. I try to anticipate as many of the questions as possible in writing these up, but the reality is that I can't anticipate all the questions. Sometimes a very good question gets asked in class that leads to insights that I've not included here. You should always talk to someone who was in class on the day you missed and compare these notes to their notes and see what the differences are.
4. This is somewhat related to the previous three items, but is important enough to merit its own item. **THESE NOTES ARE NOT A SUBSTITUTE FOR ATTENDING CLASS!!** Using these notes as a substitute for class is liable to get you in trouble. As already noted not everything in these notes is covered in class and often material or insights not in these notes is covered in class.

Multiple Integrals

Introduction

In Calculus I we moved on to the subject of integrals once we had finished the discussion of derivatives. The same is true in this course. Now that we have finished our discussion of derivatives of functions of more than one variable we need to move on to integrals of functions of two or three variables.

Most of the derivatives topics extended somewhat naturally from their Calculus I counterparts and that will be the same here. However, because we are now involving functions of two or three variables there will be some differences as well. There will be new notation and some new issues that simply don't arise when dealing with functions of a single variable.

Here is a list of topics covered in this chapter.

[Double Integrals](#) – We will define the double integral in this section.

[Iterated Integrals](#) – In this section we will start looking at how we actually compute double integrals.

[Double Integrals over General Regions](#) – Here we will look at some general double integrals.

[Double Integrals in Polar Coordinates](#) – In this section we will take a look at evaluating double integrals using polar coordinates.

[Triple Integrals](#) – Here we will define the triple integral as well as how we evaluate them.

[Triple Integrals in Cylindrical Coordinates](#) – We will evaluate triple integrals using cylindrical coordinates in this section.

[Triple Integrals in Spherical Coordinates](#) – In this section we will evaluate triple integrals using spherical coordinates.

[Change of Variables](#) – In this section we will look at change of variables for double and triple integrals.

[Surface Area](#) – Here we look at the one real application of double integrals that we're going to look at in this material.

[Area and Volume Revisited](#) – We summarize the area and volume formulas from this chapter.

Double Integrals

Before starting on double integrals let's do a quick review of the definition of a definite integrals for functions of single variables. First, when working with the integral,

$$\int_a^b f(x) dx$$

we think of x 's as coming from the interval $a \leq x \leq b$. For these integrals we can say that we are integrating over the interval $a \leq x \leq b$. Note that this does assume that $a < b$, however, if we have $b < a$ then we can just use the interval $b \leq x \leq a$.

Now, when we [derived](#) the definition of the definite integral we first thought of this as an area problem. We first asked what the area under the curve was and to do this we broke up the interval $a \leq x \leq b$ into n subintervals of width Δx and choose a point, x_i^* , from each interval as shown below,

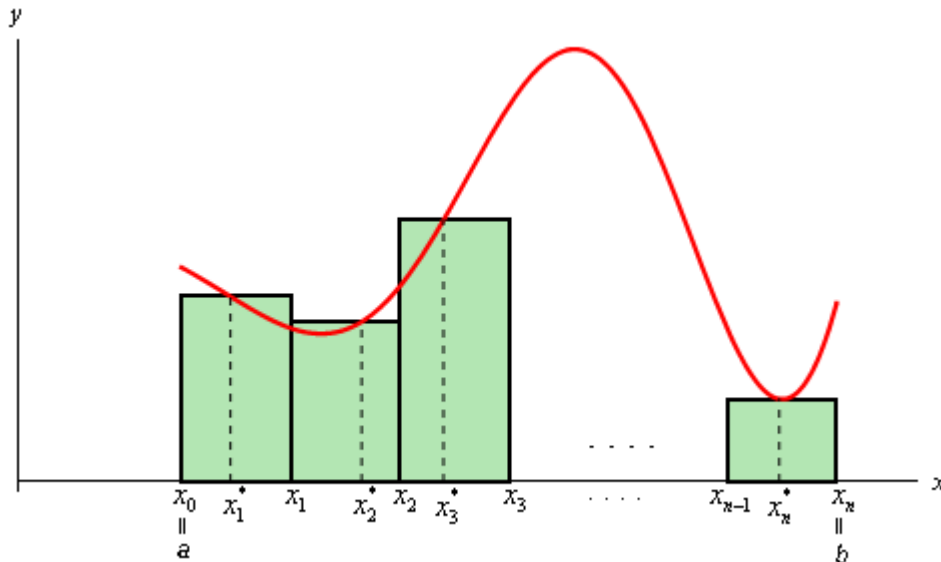

Each of the rectangles has height of $f(x_i^*)$ and we could then use the area of each of these rectangles to approximate the area as follows.

$$A \approx f(x_1^*)\Delta x + f(x_2^*)\Delta x + \cdots + f(x_i^*)\Delta x + \cdots + f(x_n^*)\Delta x$$

To get the exact area we then took the limit as n goes to infinity and this was also the definition of the definite integral.

$$\int_a^b f(x) dx = \lim_{n \rightarrow \infty} \sum_{i=1}^n f(x_i^*)\Delta x$$

In this section we want to integrate a function of two variables, $f(x, y)$. With functions of one variable we integrated over an interval (*i.e.* a one-dimensional space) and so it makes some sense then that when integrating a function of two variables we will integrate over a region of \mathbb{R}^2 (two-dimensional space).

We will start out by assuming that the region in \mathbb{R}^2 is a rectangle which we will denote as follows,

$$R = [a, b] \times [c, d]$$

This means that the ranges for x and y are $a \leq x \leq b$ and $c \leq y \leq d$.

Also, we will initially assume that $f(x, y) \geq 0$ although this doesn't really have to be the case. Let's start out with the graph of the surface S given by graphing $f(x, y)$ over the rectangle R .

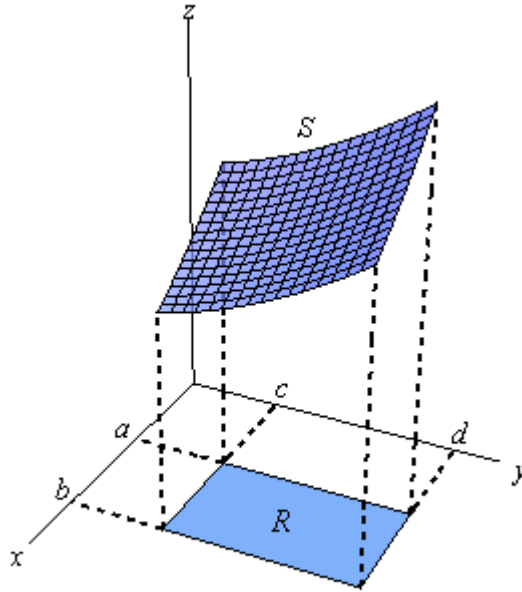

Now, just like with functions of one variable let's not worry about integrals quite yet. Let's first ask what the volume of the region under S (and above the xy -plane of course) is.

We will first approximate the volume much as we approximated the area above. We will first divide up $a \leq x \leq b$ into n subintervals and divide up $c \leq y \leq d$ into m subintervals. This will divide up R into a series of smaller rectangles and from each of these we will choose a point (x_i^*, y_j^*) . Here is a sketch of this set up.

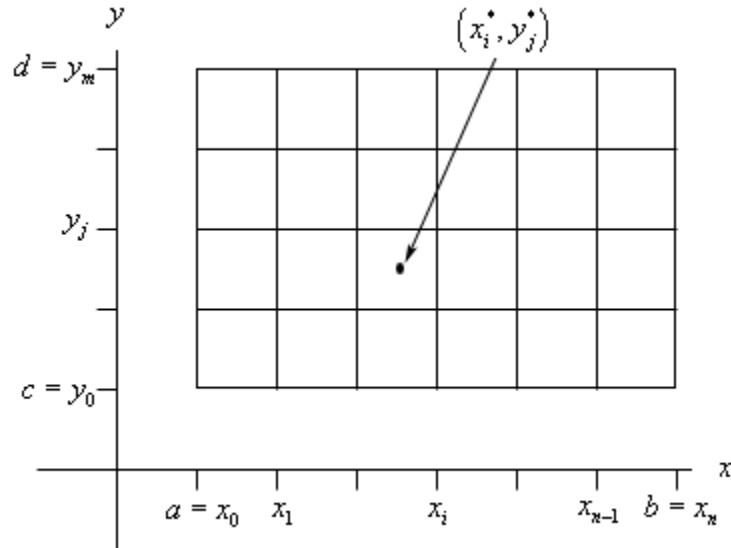

Now, over each of these smaller rectangles we will construct a box whose height is given by $f(x_i^*, y_j^*)$. Here is a sketch of that.

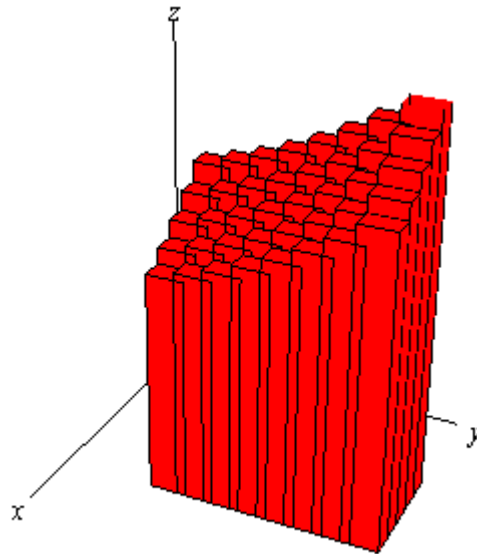

Each of the rectangles has a base area of ΔA and a height of $f(x_i^*, y_j^*)$ so the volume of each of these boxes is $f(x_i^*, y_j^*)\Delta A$. The volume under the surface S is then approximately,

$$V \approx \sum_{i=1}^n \sum_{j=1}^m f(x_i^*, y_j^*)\Delta A$$

We will have a *double* sum since we will need to add up volumes in both the x and y directions.

To get a better estimation of the volume we will take n and m larger and larger and to get the exact volume we will need to take the limit as both n and m go to infinity. In other words,

$$V = \lim_{n, m \rightarrow \infty} \sum_{i=1}^n \sum_{j=1}^m f(x_i^*, y_j^*) \Delta A$$

Now, this should look familiar. This looks a lot like the definition of the integral of a function of single variable. In fact this is also the definition of a double integral, or more exactly an integral of a function of two variables over a rectangle.

Here is the official definition of a double integral of a function of two variables over a rectangular region R as well as the notation that we'll use for it.

$$\iint_R f(x, y) dA = \lim_{n, m \rightarrow \infty} \sum_{i=1}^n \sum_{j=1}^m f(x_i^*, y_j^*) \Delta A$$

Note the similarities and differences in the notation to single integrals. We have two integrals to denote the fact that we are dealing with a two dimensional region and we have a differential here as well. Note that the differential is dA instead of the dx and dy that we're used to seeing. Note as well that we don't have limits on the integrals in this notation. Instead we have the R written below the two integrals to denote the region that we are integrating over.

Note that one interpretation of the double integral of $f(x, y)$ over the rectangle R is the volume under the function $f(x, y)$ (and above the xy -plane). Or,

$$\text{Volume} = \iint_R f(x, y) dA$$

We can use this double sum in the definition to estimate the value of a double integral if we need to. We can do this by choosing (x_i^*, y_j^*) to be the midpoint of each rectangle. When we do this we usually denote the point as (\bar{x}_i, \bar{y}_j) . This leads to the **Midpoint Rule**,

$$\iint_R f(x, y) dA \approx \sum_{i=1}^n \sum_{j=1}^m f(\bar{x}_i, \bar{y}_j) \Delta A$$

In the next section we start looking at how to actually compute double integrals.

Iterated Integrals

In the previous section we gave the definition of the double integral. However, just like with the definition of a single integral the definition is very difficult to use in practice and so we need to start looking into how we actually compute double integrals. We will continue to assume that we are integrating over the rectangle

$$R = [a, b] \times [c, d]$$

We will look at more general regions in the next section.

The following theorem tells us how to compute a double integral over a rectangle.

Fubini's Theorem

If $f(x, y)$ is continuous on $R = [a, b] \times [c, d]$ then,

$$\iint_R f(x, y) dA = \int_a^b \int_c^d f(x, y) dy dx = \int_c^d \int_a^b f(x, y) dx dy$$

These integrals are called **iterated integrals**.

Note that there are in fact two ways of computing a double integral and also notice that the inner differential matches up with the limits on the inner integral and similarly for the outer differential and limits. In other words, if the inner differential is dy then the limits on the inner integral must be y limits of integration and if the outer differential is dx then the limits on the outer integral must be x limits of integration.

Now, on some level this is just notation and doesn't really tell us how to compute the double integral. Let's just take the first possibility above and change the notation a little.

$$\iint_R f(x, y) dA = \int_a^b \left[\int_c^d f(x, y) dy \right] dx$$

We will compute the double integral by first computing

$$\int_c^d f(x, y) dy$$

and we compute this by holding x constant and integrating with respect to y as if this were an single integral. This will give a function involving only x 's which we can in turn integrate.

We've done a similar process with partial derivatives. To take the derivative of a function with respect to y we treated the x 's as constants and differentiated with respect to y as if it was a function of a single variable.

Double integrals work in the same manner. We think of all the x 's as constants and integrate with respect to y or we think of all y 's as constants and integrate with respect to x .

Let's take a look at some examples.

Example 1 Compute each of the following double integrals over the indicated rectangles.

(a) $\iint_R 6xy^2 dA$, $R = [2, 4] \times [1, 2]$ [Solution]

(b) $\iint_R 2x - 4y^3 dA$, $R = [-5, 4] \times [0, 3]$ [Solution]

(c) $\iint_R x^2 y^2 + \cos(\pi x) + \sin(\pi y) dA$, $R = [-2, -1] \times [0, 1]$ [Solution]

(d) $\iint_R \frac{1}{(2x+3y)^2} dA$, $R = [0, 1] \times [1, 2]$ [Solution]

(e) $\iint_R xe^{xy} dA$, $R = [-1, 2] \times [0, 1]$ [Solution]

Solution

(a) $\iint_R 6xy^2 dA$, $R = [2, 4] \times [1, 2]$

It doesn't matter which variable we integrate with respect to first, we will get the same answer regardless of the order of integration. To prove that let's work this one with each order to make sure that we do get the same answer.

Solution 1

In this case we will integrate with respect to y first. So, the iterated integral that we need to compute is,

$$\iint_R 6xy^2 dA = \int_2^4 \int_1^2 6xy^2 dy dx$$

When setting these up make sure the limits match up to the differentials. Since the dy is the inner differential (*i.e.* we are integrating with respect to y first) the inner integral needs to have y limits.

To compute this we will do the inner integral first and we typically keep the outer integral around as follows,

$$\begin{aligned} \iint_R 6xy^2 dA &= \int_2^4 (2xy^3) \Big|_1^2 dx \\ &= \int_2^4 16x - 2x dx \\ &= \int_2^4 14x dx \end{aligned}$$

Remember that we treat the x as a constant when doing the first integral and we don't do any integration with it yet. Now, we have a normal single integral so let's finish the integral by computing this.

$$\iint_R 6xy^2 dA = 7x^2 \Big|_2^4 = 84$$

Solution 2

In this case we'll integrate with respect to x first and then y . Here is the work for this solution.

$$\begin{aligned}\iint_R 6xy^2 dA &= \int_1^2 \int_2^4 6xy^2 dx dy \\ &= \int_1^2 (3x^2 y^2) \Big|_2^4 dy \\ &= \int_1^2 36y^2 dy \\ &= 12y^3 \Big|_1^2 \\ &= 84\end{aligned}$$

Sure enough the same answer as the first solution.

So, remember that we can do the integration in any order.

[\[Return to Problems\]](#)

(b) $\iint_R 2x - 4y^3 dA$, $R = [-5, 4] \times [0, 3]$

For this integral we'll integrate with respect to y first.

$$\begin{aligned}\iint_R 2x - 4y^3 dA &= \int_{-5}^4 \int_0^3 2x - 4y^3 dy dx \\ &= \int_{-5}^4 (2xy - y^4) \Big|_0^3 dx \\ &= \int_{-5}^4 6x - 81 dx \\ &= (3x^2 - 81x) \Big|_{-5}^4 \\ &= -756\end{aligned}$$

Remember that when integrating with respect to y all x 's are treated as constants and so as far as the inner integral is concerned the $2x$ is a constant and we know that when we integrate constants with respect to y we just tack on a y and so we get $2xy$ from the first term.

[\[Return to Problems\]](#)

(c) $\iint_R x^2 y^2 + \cos(\pi x) + \sin(\pi y) dA$, $R = [-2, -1] \times [0, 1]$

In this case we'll integrate with respect to x first.

$$\begin{aligned}
\iint_R x^2 y^2 + \cos(\pi x) + \sin(\pi y) dA &= \int_0^1 \int_{-2}^{-1} x^2 y^2 + \cos(\pi x) + \sin(\pi y) dx dy \\
&= \int_0^1 \left(\frac{1}{3} x^3 y^2 + \frac{1}{\pi} \sin(\pi x) + x \sin(\pi y) \right) \Big|_{-2}^{-1} dy \\
&= \int_0^1 \frac{7}{3} y^2 + \sin(\pi y) dy \\
&= \frac{7}{9} y^3 - \frac{1}{\pi} \cos(\pi y) \Big|_0^1 \\
&= \frac{7}{9} + \frac{2}{\pi}
\end{aligned}$$

Don't forget your basic Calculus I [substitutions](#)!

[\[Return to Problems\]](#)

(d) $\iint_R \frac{1}{(2x+3y)^2} dA, \quad R = [0,1] \times [1,2]$

In this case because the limits for x are kind of nice (*i.e.* they are zero and one which are often nice for evaluation) let's integrate with respect to x first. We'll also rewrite the integrand to help with the first integration.

$$\begin{aligned}
\iint_R (2x+3y)^{-2} dA &= \int_1^2 \int_0^1 (2x+3y)^{-2} dx dy \\
&= \int_1^2 \left(-\frac{1}{2} (2x+3y)^{-1} \right) \Big|_0^1 dy \\
&= -\frac{1}{2} \int_1^2 \frac{1}{2+3y} - \frac{1}{3y} dy \\
&= -\frac{1}{2} \left(\frac{1}{3} \ln|2+3y| - \frac{1}{3} \ln|y| \right) \Big|_1^2 \\
&= -\frac{1}{6} (\ln 8 - \ln 2 - \ln 5)
\end{aligned}$$

[\[Return to Problems\]](#)

(e) $\iint_R x e^{xy} dA, \quad R = [-1,2] \times [0,1]$

Now, while we can technically integrate with respect to either variable first sometimes one way is significantly easier than the other way. In this case it will be significantly easier to integrate with respect to y first as we will see.

$$\iint_R x e^{xy} dA = \int_{-1}^2 \int_0^1 x e^{xy} dy dx$$

The y integration can be done with the quick substitution,

$$u = xy \quad du = x dy$$

which gives

$$\begin{aligned} \iint_R x e^{xy} dA &= \int_{-1}^2 e^{xy} \Big|_0^1 dx \\ &= \int_{-1}^2 e^x - 1 dx \\ &= (e^x - x) \Big|_{-1}^2 \\ &= e^2 - 2 - (e^{-1} + 1) \\ &= e^2 - e^{-1} - 3 \end{aligned}$$

So, not too bad of an integral there provided you get the substitution. Now let's see what would happen if we had integrated with respect to x first.

$$\iint_R x e^{xy} dA = \int_0^1 \int_{-1}^2 x e^{xy} dx dy$$

In order to do this we would have to use integration by parts as follows,

$$\begin{aligned} u &= x & dv &= e^{xy} dx \\ du &= dx & v &= \frac{1}{y} e^{xy} \end{aligned}$$

The integral is then,

$$\begin{aligned} \iint_R x e^{xy} dA &= \int_0^1 \left(\frac{x}{y} e^{xy} - \int \frac{1}{y} e^{xy} dx \right) \Big|_{-1}^2 dy \\ &= \int_0^1 \left(\frac{x}{y} e^{xy} - \frac{1}{y^2} e^{xy} \right) \Big|_{-1}^2 dy \\ &= \int_0^1 \left(\frac{2}{y} e^{2y} - \frac{1}{y^2} e^{2y} \right) - \left(-\frac{1}{y} e^{-y} - \frac{1}{y^2} e^{-y} \right) dy \end{aligned}$$

We're not even going to continue here as these are very difficult integrals to do.

[\[Return to Problems\]](#)

As we saw in the previous set of examples we can do the integral in either direction. However, sometimes one direction of integration is significantly easier than the other so make sure that you think about which one you should do first before actually doing the integral.

The next topic of this section is a quick fact that can be used to make some iterated integrals somewhat easier to compute on occasion.

Fact

If $f(x, y) = g(x)h(y)$ and we are integrating over the rectangle $R = [a, b] \times [c, d]$ then,

$$\iint_R f(x, y) dA = \iint_R g(x)h(y) dA = \left(\int_a^b g(x) dx \right) \left(\int_c^d h(y) dy \right)$$

So, if we can break up the function into a function only of x times a function of y then we can do the two integrals individually and multiply them together.

Let's do a quick example using this integral.

Example 2 Evaluate $\iint_R x \cos^2(y) dA$, $R = [-2, 3] \times \left[0, \frac{\pi}{2}\right]$.

Solution

Since the integrand is a function of x times a function of y we can use the fact.

$$\begin{aligned} \iint_R x \cos^2(y) dA &= \left(\int_{-2}^3 x dx \right) \left(\int_0^{\frac{\pi}{2}} \cos^2(y) dy \right) \\ &= \left(\frac{1}{2} x^2 \right) \Big|_{-2}^3 \left(\frac{1}{2} \int_0^{\frac{\pi}{2}} 1 + \cos(2y) dy \right) \\ &= \left(\frac{5}{2} \right) \left(\frac{1}{2} \left(y + \frac{1}{2} \sin(2y) \right) \Big|_0^{\frac{\pi}{2}} \right) \\ &= \frac{5\pi}{8} \end{aligned}$$

We have one more topic to discuss in this section. This topic really doesn't have anything to do with iterated integrals, but this is as good a place as any to put it and there are liable to be some questions about it at this point as well so this is as good a place as any.

What we want to do is discuss single indefinite integrals of a function of two variables. In other words we want to look at integrals like the following.

$$\int x \sec^2(2y) + 4xy dy$$

$$\int x^3 - e^{-\frac{x}{y}} dx$$

From Calculus I we know that these integrals are asking what function that we differentiated to get the integrand. However, in this case we need to pay attention to the differential (dy or dx) in the integral, because that will change things a little.

In the case of the first integral we are asking what function we differentiated with respect to y to get the integrand while in the second integral we're asking what function differentiated with

respect to x to get the integrand. For the most part answering these questions isn't that difficult. The important issue is how we deal with the constant of integration.

Here are the integrals.

$$\int x \sec^2(2y) + 4xy \, dy = \frac{x}{2} \tan(2y) + 2xy^2 + g(x)$$

$$\int x^3 - e^{-\frac{x}{y}} \, dx = \frac{1}{4}x^4 + y e^{-\frac{x}{y}} + h(y)$$

Notice that the “constants” of integration are now functions of the opposite variable. In the first integral we are differentiating with respect to y and we know that any function involving only x 's will differentiate to zero and so when integrating with respect to y we need to acknowledge that there may have been a function of only x 's in the function and so the “constant” of integration is a function of x .

Likewise, in the second integral, the “constant” of integration must be a function of y since we are integrating with respect to x . Again, remember if we differentiate the answer with respect to x then any function of only y 's will differentiate to zero.

Double Integrals Over General Regions

In the previous section we looked at double integrals over rectangular regions. The problem with this is that most of the regions are not rectangular so we need to now look at the following double integral,

$$\iint_D f(x, y) dA$$

where D is any region.

There are two types of regions that we need to look at. Here is a sketch of both of them.

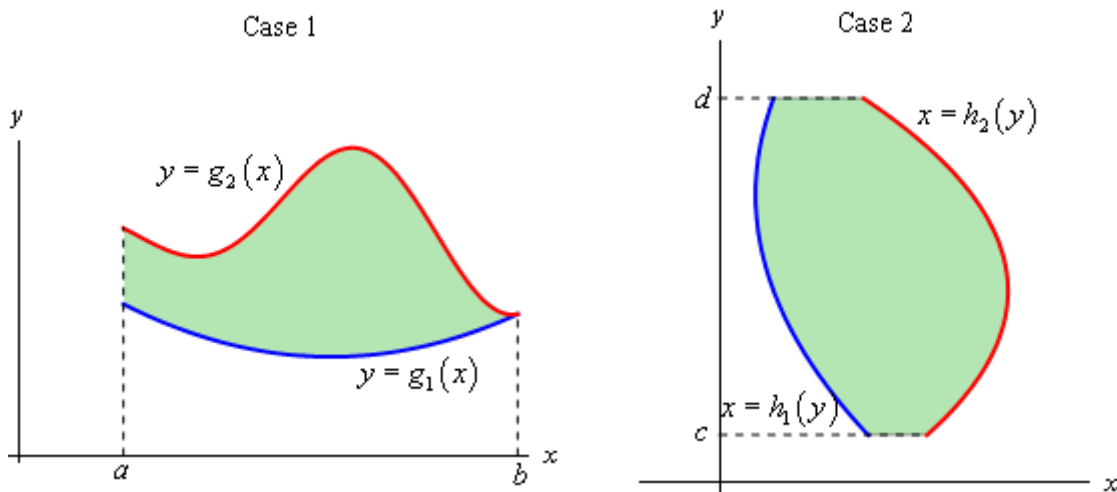

We will often use *set builder notation* to describe these regions. Here is the definition for the region in Case 1

$$D = \{(x, y) \mid a \leq x \leq b, g_1(x) \leq y \leq g_2(x)\}$$

and here is the definition for the region in Case 2.

$$D = \{(x, y) \mid h_1(y) \leq x \leq h_2(y), c \leq y \leq d\}$$

This notation is really just a fancy way of saying we are going to use all the points, (x, y) , in which both of the coordinates satisfy the two given inequalities.

The double integral for both of these cases are defined in terms of iterated integrals as follows.

In Case 1 where $D = \{(x, y) \mid a \leq x \leq b, g_1(x) \leq y \leq g_2(x)\}$ the integral is defined to be,

$$\iint_D f(x, y) dA = \int_a^b \int_{g_1(x)}^{g_2(x)} f(x, y) dy dx$$

In Case 2 where $D = \{(x, y) \mid h_1(y) \leq x \leq h_2(y), c \leq y \leq d\}$ the integral is defined to be,

$$\iint_D f(x, y) dA = \int_c^d \int_{h_1(y)}^{h_2(y)} f(x, y) dx dy$$

Here are some properties of the double integral that we should go over before we actually do some examples. Note that all three of these properties are really just extensions of properties of single integrals that have been extended to double integrals.

Properties

$$1. \iint_D f(x, y) + g(x, y) dA = \iint_D f(x, y) dA + \iint_D g(x, y) dA$$

$$2. \iint_D cf(x, y) dA = c \iint_D f(x, y) dA, \text{ where } c \text{ is any constant.}$$

3. If the region D can be split into two separate regions D_1 and D_2 then the integral can be written as

$$\iint_D f(x, y) dA = \iint_{D_1} f(x, y) dA + \iint_{D_2} f(x, y) dA$$

Let's take a look at some examples of double integrals over general regions.

Example 1 Evaluate each of the following integrals over the given region D .

$$(a) \iint_D e^{\frac{x}{y}} dA, \quad D = \{(x, y) \mid 1 \leq y \leq 2, y \leq x \leq y^3\} \quad [\text{Solution}]$$

$$(b) \iint_D 4xy - y^3 dA, \quad D \text{ is the region bounded by } y = \sqrt{x} \text{ and } y = x^3. \quad [\text{Solution}]$$

$$(c) \iint_D 6x^2 - 40y dA, \quad D \text{ is the triangle with vertices } (0, 3), (1, 1), \text{ and } (5, 3). \quad [\text{Solution}]$$

Solution

$$(a) \iint_D e^{\frac{x}{y}} dA, \quad D = \{(x, y) \mid 1 \leq y \leq 2, y \leq x \leq y^3\}$$

Okay, this first one is set up to just use the formula above so let's do that.

$$\begin{aligned} \iint_D e^{\frac{x}{y}} dA &= \int_1^2 \int_y^{y^3} e^{\frac{x}{y}} dx dy = \int_1^2 y e^{\frac{x}{y}} \Big|_y^{y^3} dy \\ &= \int_1^2 y e^{y^2} - y e^1 dy \\ &= \left(\frac{1}{2} e^{y^2} - \frac{1}{2} y^2 e^1 \right) \Big|_1^2 = \frac{1}{2} e^4 - 2e^1 \end{aligned}$$

[\[Return to Problems\]](#)

(b) $\iint_D 4xy - y^3 \, dA$, D is the region bounded by $y = \sqrt{x}$ and $y = x^3$.

In this case we need to determine the two inequalities for x and y that we need to do the integral. The best way to do this is the graph the two curves. Here is a sketch.

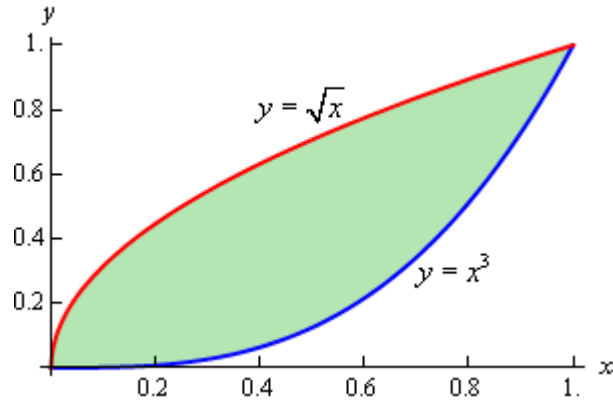

So, from the sketch we can see that that two inequalities are,

$$0 \leq x \leq 1 \quad x^3 \leq y \leq \sqrt{x}$$

We can now do the integral,

$$\begin{aligned} \iint_D 4xy - y^3 \, dA &= \int_0^1 \int_{x^3}^{\sqrt{x}} 4xy - y^3 \, dy \, dx \\ &= \int_0^1 \left(2xy^2 - \frac{1}{4}y^4 \right) \Big|_{x^3}^{\sqrt{x}} \, dx \\ &= \int_0^1 \frac{7}{4}x^2 - 2x^7 + \frac{1}{4}x^{12} \, dx \\ &= \left(\frac{7}{12}x^3 - \frac{1}{4}x^8 + \frac{1}{52}x^{13} \right) \Big|_0^1 = \frac{55}{156} \end{aligned}$$

[\[Return to Problems\]](#)

(c) $\iint_D 6x^2 - 40y \, dA$, D is the triangle with vertices $(0,3)$, $(1,1)$, and $(5,3)$.

We got even less information about the region this time. Let's start this off by sketching the triangle.

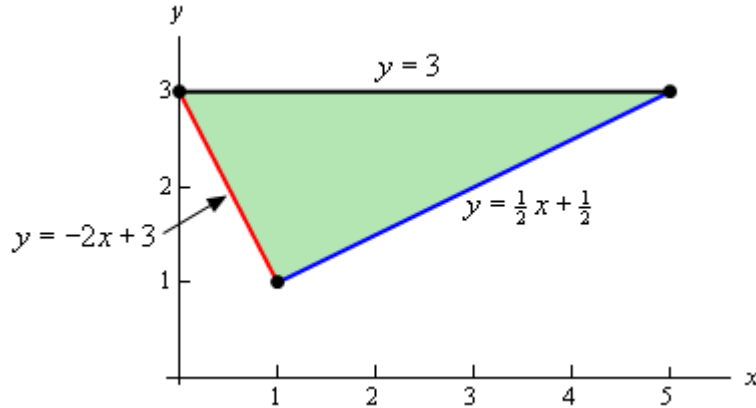

Since we have two points on each edge it is easy to get the equations for each edge and so we'll leave it to you to verify the equations.

Now, there are two ways to describe this region. If we use functions of x , as shown in the image we will have to break the region up into two different pieces since the lower function is different depending upon the value of x . In this case the region would be given by $D = D_1 \cup D_2$ where,

$$D_1 = \left\{ (x, y) \mid 0 \leq x \leq 1, -2x + 3 \leq y \leq 3 \right\}$$

$$D_2 = \left\{ (x, y) \mid 1 \leq x \leq 5, \frac{1}{2}x + \frac{1}{2} \leq y \leq 3 \right\}$$

Note the \cup is the "union" symbol and just means that D is the region we get by combining the two regions. If we do this then we'll need to do two separate integrals, one for each of the regions.

To avoid this we could turn things around and solve the two equations for x to get,

$$y = -2x + 3 \quad \Rightarrow \quad x = -\frac{1}{2}y + \frac{3}{2}$$

$$y = \frac{1}{2}x + \frac{1}{2} \quad \Rightarrow \quad x = 2y - 1$$

If we do this we can notice that the same function is always on the right and the same function is always on the left and so the region is,

$$D = \left\{ (x, y) \mid -\frac{1}{2}y + \frac{3}{2} \leq x \leq 2y - 1, 1 \leq y \leq 3 \right\}$$

Writing the region in this form means doing a single integral instead of the two integrals we'd have to do otherwise.

Either way should give the same answer and so we can get an example in the notes of splitting a region up let's do both integrals.

Solution 1

$$\begin{aligned}
\iint_D 6x^2 - 40y \, dA &= \iint_{D_1} 6x^2 - 40y \, dA + \iint_{D_2} 6x^2 - 40y \, dA \\
&= \int_0^1 \int_{-2x+3}^3 6x^2 - 40y \, dy \, dx + \int_1^5 \int_{\frac{1}{2}x+\frac{1}{2}}^3 6x^2 - 40y \, dy \, dx \\
&= \int_0^1 (6x^2y - 20y^2) \Big|_{-2x+3}^3 \, dx + \int_1^5 (6x^2y - 20y^2) \Big|_{\frac{1}{2}x+\frac{1}{2}}^3 \, dx \\
&= \int_0^1 12x^3 - 180 + 20(3-2x)^2 \, dx + \int_1^5 -3x^3 + 15x^2 - 180 + 20\left(\frac{1}{2}x + \frac{1}{2}\right)^2 \, dx \\
&= \left(3x^4 - 180x - \frac{10}{3}(3-2x)^3\right) \Big|_0^1 + \left(-\frac{3}{4}x^4 + 5x^3 - 180x + \frac{40}{3}\left(\frac{1}{2}x + \frac{1}{2}\right)^3\right) \Big|_1^5 \\
&= -\frac{935}{3}
\end{aligned}$$

That was a lot of work. Notice however, that after we did the first substitution that we didn't multiply everything out. The two quadratic terms can be easily integrated with a basic Calc I substitution and so we didn't bother to multiply them out. We'll do that on occasion to make some of these integrals a little easier.

Solution 2

This solution will be a lot less work since we are only going to do a single integral.

$$\begin{aligned}
\iint_D 6x^2 - 40y \, dA &= \int_1^3 \int_{-\frac{1}{2}y+\frac{3}{2}}^{2y-1} 6x^2 - 40y \, dx \, dy \\
&= \int_1^3 (2x^3 - 40xy) \Big|_{-\frac{1}{2}y+\frac{3}{2}}^{2y-1} \, dy \\
&= \int_1^3 100y - 100y^2 + 2(2y-1)^3 - 2\left(-\frac{1}{2}y + \frac{3}{2}\right)^3 \, dy \\
&= \left(50y^2 - \frac{100}{3}y^3 + \frac{1}{4}(2y-1)^4 + \left(-\frac{1}{2}y + \frac{3}{2}\right)^4\right) \Big|_1^3 \\
&= -\frac{935}{3}
\end{aligned}$$

So, the numbers were a little messier, but other than that there was much less work for the same result. Also notice that again we didn't cube out the two terms as they are easier to deal with using a Calc I substitution.

[\[Return to Problems\]](#)

As the last part of the previous example has shown us we can integrate these integrals in either order (*i.e.* x followed by y or y followed by x), although often one order will be easier than the other. In fact there will be times when it will not even be possible to do the integral in one order while it will be possible to do the integral in the other order.

Let's see a couple of examples of these kinds of integrals.

Example 2 Evaluate the following integrals by first reversing the order of integration.

(a) $\int_0^3 \int_{x^2}^9 x^3 e^{y^3} dy dx$ [Solution]

(b) $\int_0^8 \int_{\sqrt[3]{y}}^2 \sqrt{x^4 + 1} dx dy$ [Solution]

Solution

(a) $\int_0^3 \int_{x^2}^9 x^3 e^{y^3} dy dx$

First, notice that if we try to integrate with respect to y we can't do the integral because we would need a y^2 in front of the exponential in order to do the y integration. We are going to hope that if we reverse the order of integration we will get an integral that we can do.

Now, when we say that we're going to reverse the order of integration this means that we want to integrate with respect to x first and then y . Note as well that we can't just interchange the integrals, keeping the original limits, and be done with it. This would not fix our original problem and in order to integrate with respect to x we can't have x 's in the limits of the integrals. Even if we ignored that the answer would not be a constant as it should be.

So, let's see how we reverse the order of integration. The best way to reverse the order of integration is to first sketch the region given by the original limits of integration. From the integral we see that the inequalities that define this region are,

$$0 \leq x \leq 3$$

$$x^2 \leq y \leq 9$$

These inequalities tell us that we want the region with $y = x^2$ on the lower boundary and $y = 9$ on the upper boundary that lies between $x = 0$ and $x = 3$. Here is a sketch of that region.

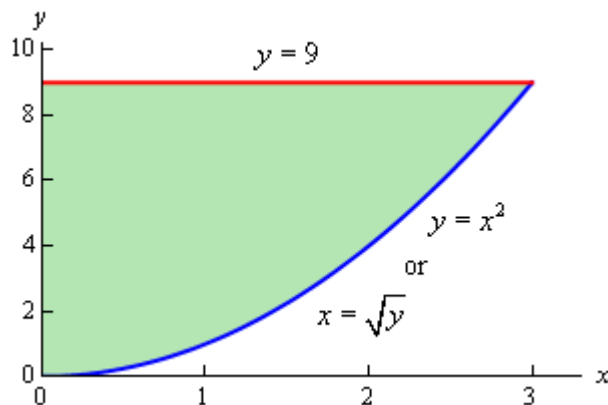

Since we want to integrate with respect to x first we will need to determine limits of x (probably in terms of y) and then get the limits on the y 's. Here they are for this region.

$$0 \leq x \leq \sqrt{y}$$

$$0 \leq y \leq 9$$

Any horizontal line drawn in this region will start at $x = 0$ and end at $x = \sqrt{y}$ and so these are the limits on the x 's and the range of y 's for the regions is 0 to 9.

The integral, with the order reversed, is now,

$$\int_0^3 \int_{x^2}^9 x^3 e^{y^3} dy dx = \int_0^9 \int_0^{\sqrt{y}} x^3 e^{y^3} dx dy$$

and notice that we can do the first integration with this order. We'll also hope that this will give us a second integral that we can do. Here is the work for this integral.

$$\begin{aligned} \int_0^3 \int_{x^2}^9 x^3 e^{y^3} dy dx &= \int_0^9 \int_0^{\sqrt{y}} x^3 e^{y^3} dx dy \\ &= \int_0^9 \left. \frac{1}{4} x^4 e^{y^3} \right|_0^{\sqrt{y}} dy \\ &= \int_0^9 \frac{1}{4} y^2 e^{y^3} dy \\ &= \left. \frac{1}{12} e^{y^3} \right|_0^9 \\ &= \frac{1}{12} (e^{729} - 1) \end{aligned}$$

[\[Return to Problems\]](#)

(b) $\int_0^8 \int_{\sqrt[3]{y}}^2 \sqrt{x^4 + 1} dx dy$

As with the first integral we cannot do this integral by integrating with respect to x first so we'll hope that by reversing the order of integration we will get something that we can integrate. Here are the limits for the variables that we get from this integral.

$$\begin{aligned} \sqrt[3]{y} &\leq x \leq 2 \\ 0 &\leq y \leq 8 \end{aligned}$$

and here is a sketch of this region.

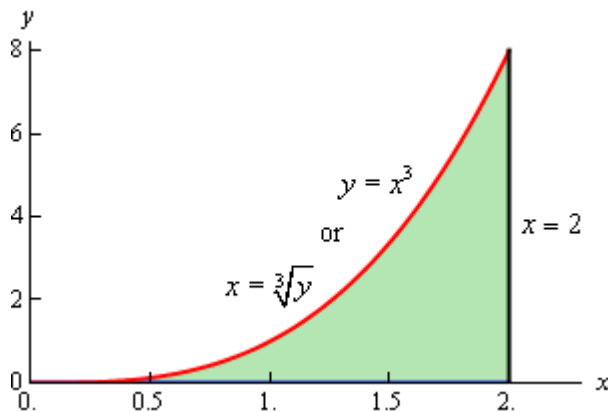

So, if we reverse the order of integration we get the following limits.

$$0 \leq x \leq 2$$

$$0 \leq y \leq x^3$$

The integral is then,

$$\begin{aligned} \int_0^8 \int_{\sqrt[3]{y}}^2 \sqrt{x^4 + 1} \, dx \, dy &= \int_0^2 \int_0^{x^3} \sqrt{x^4 + 1} \, dy \, dx \\ &= \int_0^2 y \sqrt{x^4 + 1} \Big|_0^{x^3} \, dx \\ &= \int_0^2 x^3 \sqrt{x^4 + 1} \, dx = \frac{1}{6} \left(17^{\frac{3}{2}} - 1 \right) \end{aligned}$$

[\[Return to Problems\]](#)

The final topic of this section is two geometric interpretations of a double integral. The first interpretation is an extension of the idea that we used to develop the idea of a double integral in the first [section](#) of this chapter. We did this by looking at the volume of the solid that was below the surface of the function $z = f(x, y)$ and over the rectangle R in the xy -plane. This idea can be extended to more general regions.

The volume of the solid that lies below the surface given by $z = f(x, y)$ and above the region D in the xy -plane is given by,

$$V = \iint_D f(x, y) \, dA$$

Example 3 Find the volume of the solid that lies below the surface given by $z = 16xy + 200$ and lies above the region in the xy -plane bounded by $y = x^2$ and $y = 8 - x^2$.

Solution

Here is the graph of the surface and we've tried to show the region in the xy -plane below the surface.

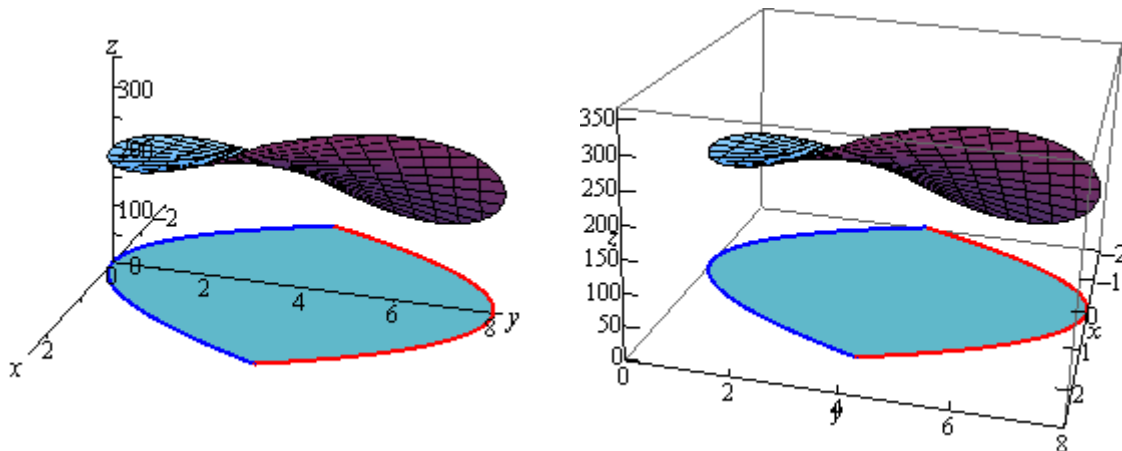

Here is a sketch of the region in the xy -plane by itself.

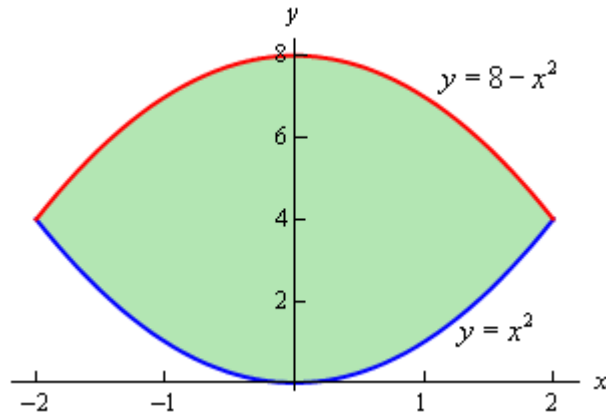

By setting the two bounding equations equal we can see that they will intersect at $x = 2$ and $x = -2$. So, the inequalities that will define the region D in the xy -plane are,

$$\begin{aligned} -2 \leq x \leq 2 \\ x^2 \leq y \leq 8 - x^2 \end{aligned}$$

The volume is then given by,

$$\begin{aligned} V &= \iint_D 16xy + 200 \, dA \\ &= \int_{-2}^2 \int_{x^2}^{8-x^2} 16xy + 200 \, dy \, dx \\ &= \int_{-2}^2 (8xy^2 + 200y) \Big|_{x^2}^{8-x^2} \, dx \\ &= \int_{-2}^2 -128x^3 - 400x^2 + 512x + 1600 \, dx \\ &= \left(-32x^4 - \frac{400}{3}x^3 + 256x^2 + 1600x \right) \Big|_{-2}^2 = \frac{12800}{3} \end{aligned}$$

Example 4 Find the volume of the solid enclosed by the planes $4x + 2y + z = 10$, $y = 3x$, $z = 0$, $x = 0$.

Solution This example is a little different from the previous one. Here the region D is not explicitly given so we're going to have to find it. First, notice that the last two planes are really telling us that we won't go past the xy -plane and the yz -plane when we reach them.

The first plane, $4x + 2y + z = 10$, is the top of the volume and so we are really looking for the volume under,

$$z = 10 - 4x - 2y$$

and above the region D in the xy -plane. The second plane, $y = 3x$ (yes that is a plane), gives one of the sides of the volume as shown below.

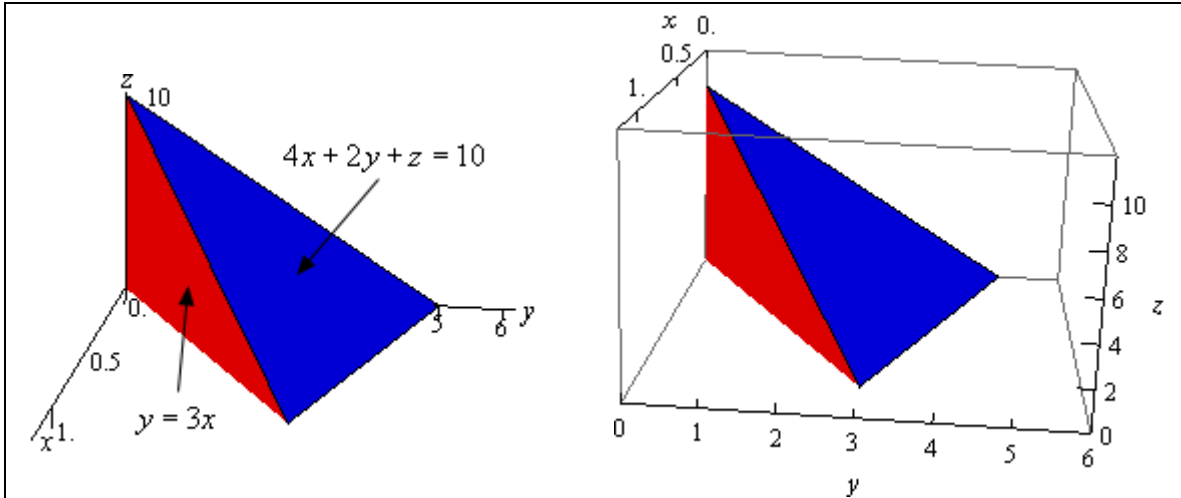

The region D will be the region in the xy -plane (*i.e.* $z = 0$) that is bounded by $y = 3x$, $x = 0$, and the line where $z + 4x + 2y = 10$ intersects the xy -plane. We can determine where $z + 4x + 2y = 10$ intersects the xy -plane by plugging $z = 0$ into it.

$$0 + 4x + 2y = 10 \quad \Rightarrow \quad 2x + y = 5 \quad \Rightarrow \quad y = -2x + 5$$

So, here is a sketch the region D .

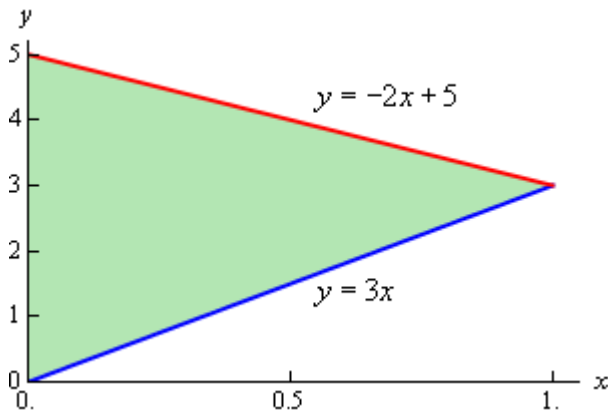

The region D is really where this solid will sit on the xy -plane and here are the inequalities that define the region.

$$0 \leq x \leq 1$$

$$3x \leq y \leq -2x + 5$$

Here is the volume of this solid.

$$\begin{aligned}
 V &= \iint_D 10 - 4x - 2y \, dA \\
 &= \int_0^1 \int_{3x}^{-2x+5} 10 - 4x - 2y \, dy \, dx \\
 &= \int_0^1 (10y - 4xy - y^2) \Big|_{3x}^{-2x+5} \, dx \\
 &= \int_0^1 25x^2 - 50x + 25 \, dx \\
 &= \left(\frac{25}{3}x^3 - 25x^2 + 25x \right) \Big|_0^1 = \frac{25}{3}
 \end{aligned}$$

The second geometric interpretation of a double integral is the following.

$$\text{Area of } D = \iint_D dA$$

This is easy to see why this is true in general. Let's suppose that we want to find the area of the region shown below.

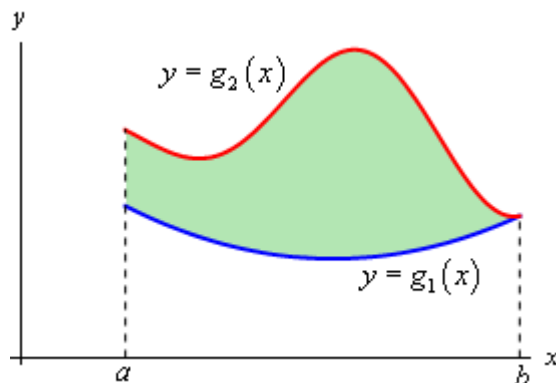

From Calculus I we know that this area can be found by the integral,

$$A = \int_a^b g_2(x) - g_1(x) \, dx$$

Or in terms of a double integral we have,

$$\begin{aligned}
 \text{Area of } D &= \iint_D dA \\
 &= \int_a^b \int_{g_1(x)}^{g_2(x)} dy \, dx \\
 &= \int_a^b y \Big|_{g_1(x)}^{g_2(x)} dx = \int_a^b g_2(x) - g_1(x) \, dx
 \end{aligned}$$

This is exactly the same formula we had in Calculus I.

Double Integrals in Polar Coordinates

To this point we've seen quite a few double integrals. However, in every case we've seen to this point the region D could be easily described in terms of simple functions in Cartesian coordinates. In this section we want to look at some regions that are much easier to describe in terms of polar coordinates. For instance, we might have a region that is a disk, ring, or a portion of a disk or ring. In these cases using Cartesian coordinates could be somewhat cumbersome. For instance let's suppose we wanted to do the following integral,

$$\iint_D f(x, y) dA, \quad D \text{ is the disk of radius } 2$$

To this we would have to determine a set of inequalities for x and y that describe this region. These would be,

$$\begin{aligned} -2 &\leq x \leq 2 \\ -\sqrt{4-x^2} &\leq y \leq \sqrt{4-x^2} \end{aligned}$$

With these limits the integral would become,

$$\iint_D f(x, y) dA = \int_{-2}^2 \int_{-\sqrt{4-x^2}}^{\sqrt{4-x^2}} f(x, y) dy dx$$

Due to the limits on the inner integral this is liable to be an unpleasant integral to compute.

However, a disk of radius 2 can be defined in polar coordinates by the following inequalities,

$$\begin{aligned} 0 &\leq \theta \leq 2\pi \\ 0 &\leq r \leq 2 \end{aligned}$$

These are very simple limits and, in fact, are constant limits of integration which almost always makes integrals somewhat easier.

So, if we could convert our double integral formula into one involving polar coordinates we would be in pretty good shape. The problem is that we can't just convert the dx and the dy into a dr and a $d\theta$. In computing double integrals to this point we have been using the fact that $dA = dx dy$ and this really does require Cartesian coordinates to use. Once we've moved into polar coordinates $dA \neq dr d\theta$ and so we're going to need to determine just what dA is under polar coordinates.

So, let's step back a little bit and start off with a general region in terms of polar coordinates and see what we can do with that. Here is a sketch of some region using polar coordinates.

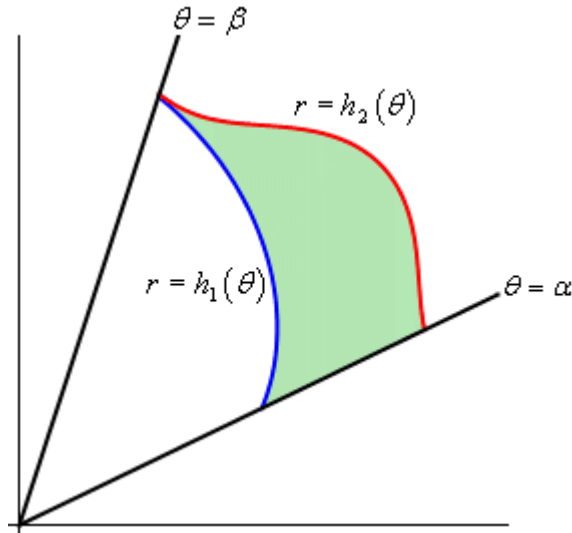

So, our general region will be defined by inequalities,

$$\alpha \leq \theta \leq \beta$$

$$h_1(\theta) \leq r \leq h_2(\theta)$$

Now, to find dA let's redo the figure above as follows,

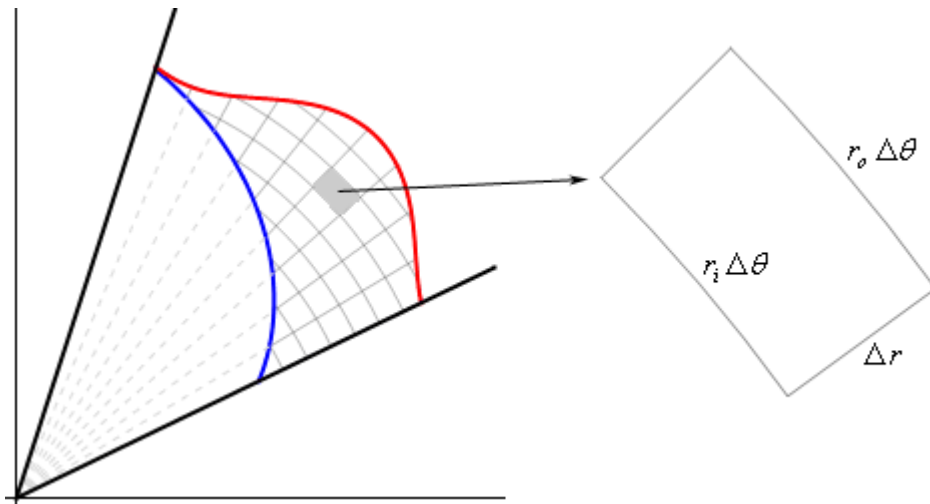

As shown, we'll break up the region into a mesh of radial lines and arcs. Now, if we pull one of the pieces of the mesh out as shown we have something that is almost, but not quite a rectangle. The area of this piece is ΔA . The two sides of this piece both have length $\Delta r = r_o - r_i$ where r_o is the radius of the outer arc and r_i is the radius of the inner arc. Basic geometry then tells us that the length of the inner edge is $r_i \Delta \theta$ while the length of the out edge is $r_o \Delta \theta$ where $\Delta \theta$ is the angle between the two radial lines that form the sides of this piece.

Now, let's assume that we've taken the mesh so small that we can assume that $r_i \approx r_o = r$ and with this assumption we can also assume that our piece is close enough to a rectangle that we can also then assume that,

$$\Delta A \approx r \Delta \theta \Delta r$$

Also, if we assume that the mesh is small enough then we can also assume that,

$$dA \approx \Delta A \qquad d\theta \approx \Delta \theta \qquad dr \approx \Delta r$$

With these assumptions we then get $dA \approx r dr d\theta$.

In order to arrive at this we had to make the assumption that the mesh was very small. This is not an unreasonable assumption. [Recall](#) that the definition of a double integral is in terms of two limits and as limits go to infinity the mesh size of the region will get smaller and smaller. In fact, as the mesh size gets smaller and smaller the formula above becomes more and more accurate and so we can say that,

$$dA = r dr d\theta$$

We'll see another way of deriving this once we reach the [Change of Variables](#) section later in this chapter. This second way will not involve any assumptions either and so it may be a little better way of deriving this.

Before moving on it is again important to note that $dA \neq dr d\theta$. The actual formula for dA has an r in it. It will be easy to forget this r on occasion, but as you'll see without it some integrals will not be possible to do.

Now, if we're going to be converting an integral in Cartesian coordinates into an integral in polar coordinates we are going to have to make sure that we've also converted all the x 's and y 's into polar coordinates as well. To do this we'll need to remember the following conversion formulas,

$$x = r \cos \theta \qquad y = r \sin \theta \qquad r^2 = x^2 + y^2$$

We are now ready to write down a formula for the double integral in terms of polar coordinates.

$$\iint_D f(x, y) dA = \int_{\alpha}^{\beta} \int_{h_1(\theta)}^{h_2(\theta)} f(r \cos \theta, r \sin \theta) r dr d\theta$$

It is important to not forget the added r and don't forget to convert the Cartesian coordinates in the function over to polar coordinates.

Let's look at a couple of examples of these kinds of integrals.

Example 1 Evaluate the following integrals by converting them into polar coordinates.

(a) $\iint_D 2xy \, dA$, D is the portion of the region between the circles of radius 2 and radius 5 centered at the origin that lies in the first quadrant. [\[Solution\]](#)

(b) $\iint_D e^{x^2+y^2} \, dA$, D is the unit circle centered at the origin. [\[Solution\]](#)

Solution

(a) $\iint_D 2xy \, dA$, D is the portion of the region between the circles of radius 2 and radius 5 centered at the origin that lies in the first quadrant.

First let's get D in terms of polar coordinates. The circle of radius 2 is given by $r = 2$ and the circle of radius 5 is given by $r = 5$. We want the region between them so we will have the following inequality for r .

$$2 \leq r \leq 5$$

Also, since we only want the portion that is in the first quadrant we get the following range of θ 's.

$$0 \leq \theta \leq \frac{\pi}{2}$$

Now that we've got these we can do the integral.

$$\iint_D 2xy \, dA = \int_0^{\frac{\pi}{2}} \int_2^5 2(r \cos \theta)(r \sin \theta)r \, dr \, d\theta$$

Don't forget to do the conversions and to add in the extra r . Now, let's simplify and make use of the double angle formula for sine to make the integral a little easier.

$$\begin{aligned} \iint_D 2xy \, dA &= \int_0^{\frac{\pi}{2}} \int_2^5 r^3 \sin(2\theta) \, dr \, d\theta \\ &= \int_0^{\frac{\pi}{2}} \frac{1}{4} r^4 \sin(2\theta) \Big|_2^5 \, d\theta \\ &= \int_0^{\frac{\pi}{2}} \frac{609}{4} \sin(2\theta) \, d\theta \\ &= -\frac{609}{8} \cos(2\theta) \Big|_0^{\frac{\pi}{2}} \\ &= \frac{609}{4} \end{aligned}$$

[\[Return to Problems\]](#)

(b) $\iint_D e^{x^2+y^2} dA$, D is the unit circle centered at the origin.

In this case we can't do this integral in terms of Cartesian coordinates. We will however be able to do it in polar coordinates. First, the region D is defined by,

$$\begin{aligned} 0 \leq \theta \leq 2\pi \\ 0 \leq r \leq 1 \end{aligned}$$

In terms of polar coordinates the integral is then,

$$\iint_D e^{x^2+y^2} dA = \int_0^{2\pi} \int_0^1 r e^{r^2} dr d\theta$$

Notice that the addition of the r gives us an integral that we can now do. Here is the work for this integral.

$$\begin{aligned} \iint_D e^{x^2+y^2} dA &= \int_0^{2\pi} \int_0^1 r e^{r^2} dr d\theta \\ &= \int_0^{2\pi} \left. \frac{1}{2} e^{r^2} \right|_0^1 d\theta \\ &= \int_0^{2\pi} \frac{1}{2} (e-1) d\theta \\ &= \pi(e-1) \end{aligned}$$

[\[Return to Problems\]](#)

Let's not forget that we still have the two geometric interpretations for these integrals as well.

Example 2 Determine the area of the region that lies inside $r = 3 + 2 \sin \theta$ and outside $r = 2$.

Solution

Here is a sketch of the region, D , that we want to determine the area of.

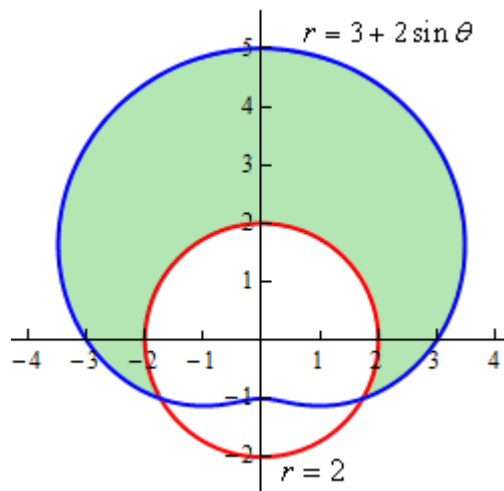

To determine this area we'll need to know that value of θ for which the two curves intersect. We can determine these points by setting the two equations and solving.

$$3 + 2 \sin \theta = 2$$

$$\sin \theta = -\frac{1}{2} \quad \Rightarrow \quad \theta = \frac{7\pi}{6}, \frac{11\pi}{6}$$

Here is a sketch of the figure with these angles added.

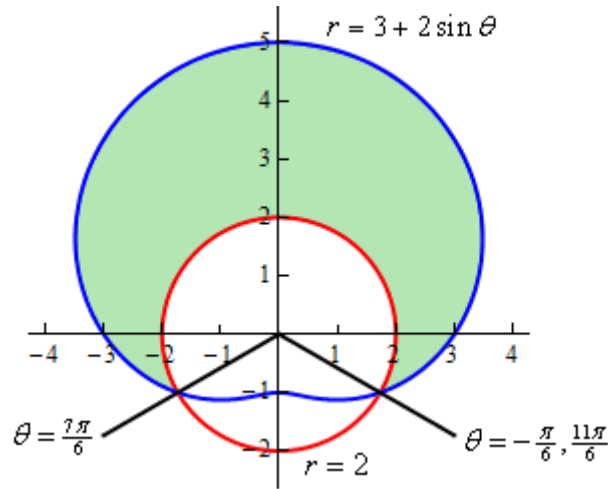

Note as well that we've acknowledged that $-\frac{\pi}{6}$ is another representation for the angle $\frac{11\pi}{6}$. This is important since we need the range of θ to actually enclose the regions as we increase from the lower limit to the upper limit. If we'd chosen to use $\frac{11\pi}{6}$ then as we increase from $\frac{7\pi}{6}$ to $\frac{11\pi}{6}$ we would be tracing out the lower portion of the circle and that is not the region that we are after.

So, here are the ranges that will define the region.

$$-\frac{\pi}{6} \leq \theta \leq \frac{7\pi}{6}$$

$$2 \leq r \leq 3 + 2 \sin \theta$$

To get the ranges for r the function that is closest to the origin is the lower bound and the function that is farthest from the origin is the upper bound.

The area of the region D is then,

$$\begin{aligned}
A &= \iint_D dA \\
&= \int_{-\pi/6}^{7\pi/6} \int_2^{3+2\sin\theta} r \, dr \, d\theta \\
&= \int_{-\pi/6}^{7\pi/6} \left. \frac{1}{2} r^2 \right|_2^{3+2\sin\theta} d\theta \\
&= \int_{-\pi/6}^{7\pi/6} \frac{5}{2} + 6\sin\theta + 2\sin^2\theta \, d\theta \\
&= \int_{-\pi/6}^{7\pi/6} \frac{7}{2} + 6\sin\theta - \cos(2\theta) \, d\theta \\
&= \left(\frac{7}{2}\theta - 6\cos\theta - \frac{1}{2}\sin(2\theta) \right) \Big|_{-\pi/6}^{7\pi/6} \\
&= \frac{11\sqrt{3}}{2} + \frac{14\pi}{3} = 24.187
\end{aligned}$$

Example 3 Determine the volume of the region that lies under the sphere $x^2 + y^2 + z^2 = 9$, above the plane $z = 0$ and inside the cylinder $x^2 + y^2 = 5$.

Solution

We know that the formula for finding the volume of a region is,

$$V = \iint_D f(x, y) \, dA$$

In order to make use of this formula we're going to need to determine the function that we should be integrating and the region D that we're going to be integrating over.

The function isn't too bad. It's just the sphere, however, we do need it to be in the form $z = f(x, y)$. We are looking at the region that lies under the sphere and above the plane $z = 0$ (just the xy -plane right?) and so all we need to do is solve the equation for z and when taking the square root we'll take the positive one since we are wanting the region above the xy -plane. Here is the function.

$$z = \sqrt{9 - x^2 - y^2}$$

The region D isn't too bad in this case either. As we take points, (x, y) , from the region we need to completely graph the portion of the sphere that we are working with. Since we only want the portion of the sphere that actually lies inside the cylinder given by $x^2 + y^2 = 5$ this is also the region D . The region D is the disk $x^2 + y^2 \leq 5$ in the xy -plane.

For reference purposes here is a sketch of the region that we are trying to find the volume of.

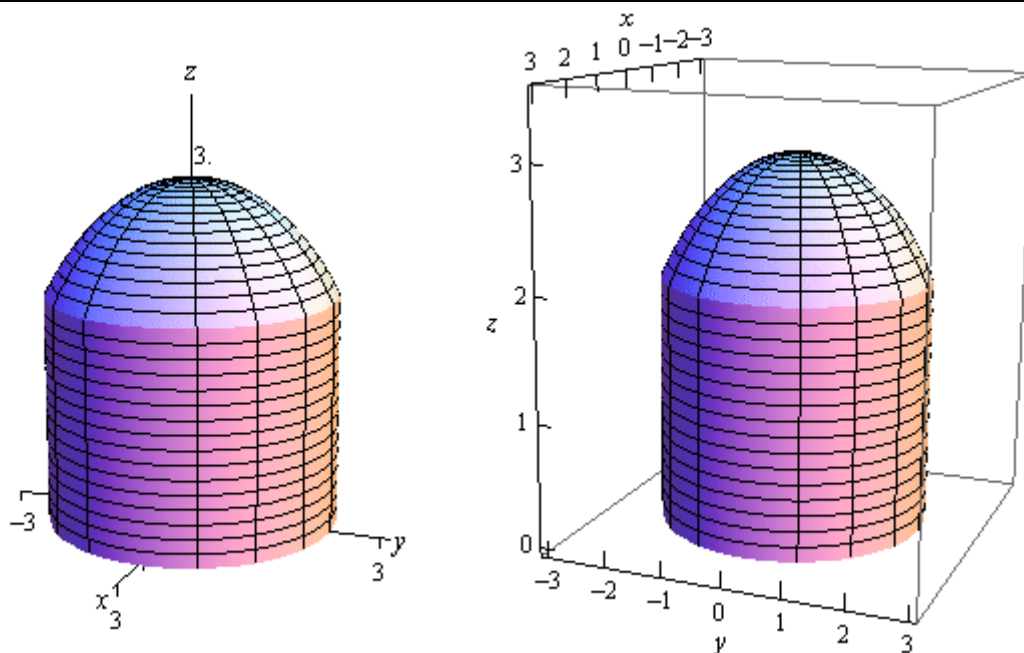

So, the region that we want the volume for is really a cylinder with a cap that comes from the sphere.

We are definitely going to want to do this integral in terms of polar coordinates so here are the limits (in polar coordinates) for the region,

$$0 \leq \theta \leq 2\pi$$

$$0 \leq r \leq \sqrt{5}$$

and we'll need to convert the function to polar coordinates as well.

$$z = \sqrt{9 - (x^2 + y^2)} = \sqrt{9 - r^2}$$

The volume is then,

$$\begin{aligned} V &= \iint_D \sqrt{9 - x^2 - y^2} \, dA \\ &= \int_0^{2\pi} \int_0^{\sqrt{5}} r \sqrt{9 - r^2} \, dr \, d\theta \\ &= \int_0^{2\pi} \left. -\frac{1}{3} (9 - r^2)^{\frac{3}{2}} \right|_0^{\sqrt{5}} d\theta \\ &= \int_0^{2\pi} \frac{19}{3} d\theta \\ &= \frac{38\pi}{3} \end{aligned}$$

Example 4 Find the volume of the region that lies inside $z = x^2 + y^2$ and below the plane $z = 16$.

Solution

Let's start this example off with a quick sketch of the region.

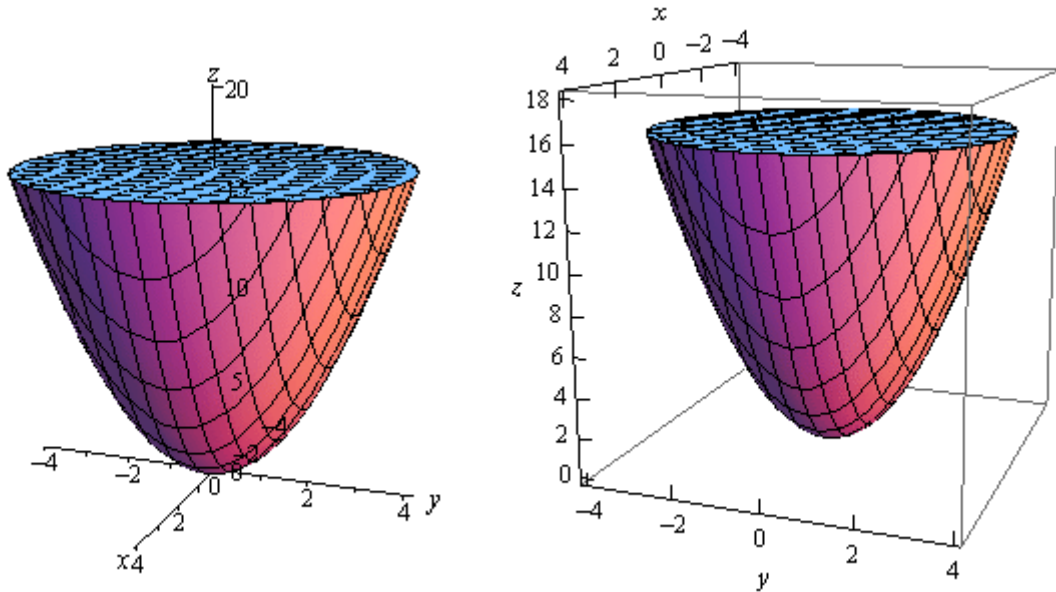

Now, in this case the standard formula is not going to work. The formula

$$V = \iint_D f(x, y) dA$$

finds the volume under the function $f(x, y)$ and we're actually after the area that is above a function. This isn't the problem that it might appear to be however. First, notice that

$$V = \iint_D 16 dA$$

will be the volume under $z = 16$ (of course we'll need to determine D eventually) while

$$V = \iint_D x^2 + y^2 dA$$

is the volume under $z = x^2 + y^2$, using the same D .

The volume that we're after is really the difference between these two or,

$$V = \iint_D 16 dA - \iint_D x^2 + y^2 dA = \iint_D 16 - (x^2 + y^2) dA$$

Now all that we need to do is to determine the region D and then convert everything over to polar coordinates.

Determining the region D in this case is not too bad. If we were to look straight down the z -axis onto the region we would see a circle of radius 4 centered at the origin. This is because the top of the region, where the elliptic paraboloid intersects the plane, is the widest part of the region. We know the z coordinate at the intersection so, setting $z = 16$ in the equation of the paraboloid gives,

$$16 = x^2 + y^2$$

which is the equation of a circle of radius 4 centered at the origin.

Here are the inequalities for the region and the function we'll be integrating in terms of polar coordinates.

$$0 \leq \theta \leq 2\pi \qquad 0 \leq r \leq 4 \qquad z = 16 - r^2$$

The volume is then,

$$\begin{aligned} V &= \iint_D 16 - (x^2 + y^2) dA \\ &= \int_0^{2\pi} \int_0^4 r(16 - r^2) dr d\theta \\ &= \int_0^{2\pi} \left(8r^2 - \frac{1}{4}r^4 \right) \Big|_0^4 d\theta \\ &= \int_0^{2\pi} 64 d\theta \\ &= 128\pi \end{aligned}$$

In both of the previous volume problems we would have not been able to easily compute the volume without first converting to polar coordinates so, as these examples show, it is a good idea to always remember polar coordinates.

There is one more type of example that we need to look at before moving on to the next section. Sometimes we are given an iterated integral that is already in terms of x and y and we need to convert this over to polar so that we can actually do the integral. We need to see an example of how to do this kind of conversion.

Example 5 Evaluate the following integral by first converting to polar coordinates.

$$\int_0^1 \int_0^{\sqrt{1-y^2}} \cos(x^2 + y^2) dx dy$$

Solution

First, notice that we cannot do this integral in Cartesian coordinates and so converting to polar coordinates may be the only option we have for actually doing the integral. Notice that the function will convert to polar coordinates nicely and so shouldn't be a problem.

Let's first determine the region that we're integrating over and see if it's a region that can be easily converted into polar coordinates. Here are the inequalities that define the region in terms of Cartesian coordinates.

$$\begin{aligned} 0 &\leq y \leq 1 \\ 0 &\leq x \leq \sqrt{1 - y^2} \end{aligned}$$

Now, the upper limit for the x 's is,

$$x = \sqrt{1 - y^2}$$

and this looks like the right side of the circle of radius 1 centered at the origin. Since the lower limit for the x 's is $x = 0$ it looks like we are going to have a portion (or all) of the right side of the disk of radius 1 centered at the origin.

The range for the y 's however, tells us that we are only going to have positive y 's. This means that we are only going to have the portion of the disk of radius 1 centered at the origin that is in the first quadrant.

So, we know that the inequalities that will define this region in terms of polar coordinates are then,

$$0 \leq \theta \leq \frac{\pi}{2}$$

$$0 \leq r \leq 1$$

Finally, we just need to remember that,

$$dx dy = dA = r dr d\theta$$

and so the integral becomes,

$$\int_0^1 \int_0^{\sqrt{1-y^2}} \cos(x^2 + y^2) dx dy = \int_0^{\frac{\pi}{2}} \int_0^1 r \cos(r^2) dr d\theta$$

Note that this is an integral that we can do. So, here is the rest of the work for this integral.

$$\begin{aligned} \int_0^1 \int_0^{\sqrt{1-y^2}} \cos(x^2 + y^2) dx dy &= \int_0^{\frac{\pi}{2}} \frac{1}{2} \sin(r^2) \Big|_0^1 d\theta \\ &= \int_0^{\frac{\pi}{2}} \frac{1}{2} \sin(1) d\theta \\ &= \frac{\pi}{4} \sin(1) \end{aligned}$$

Triple Integrals

Now that we know how to integrate over a two-dimensional region we need to move on to integrating over a three-dimensional region. We used a double integral to integrate over a two-dimensional region and so it shouldn't be too surprising that we'll use a **triple integral** to integrate over a three dimensional region. The notation for the general triple integrals is,

$$\iiint_E f(x, y, z) dV$$

Let's start simple by integrating over the box,

$$B = [a, b] \times [c, d] \times [r, s]$$

Note that when using this notation we list the x 's first, the y 's second and the z 's third.

The triple integral in this case is,

$$\iiint_B f(x, y, z) dV = \int_r^s \int_c^d \int_a^b f(x, y, z) dx dy dz$$

Note that we integrated with respect to x first, then y , and finally z here, but in fact there is no reason to the integrals in this order. There are 6 different possible orders to do the integral in and which order you do the integral in will depend upon the function and the order that you feel will be the easiest. We will get the same answer regardless of the order however.

Let's do a quick example of this type of triple integral.

Example 1 Evaluate the following integral.

$$\iiint_B 8xyz dV, \quad B = [2, 3] \times [1, 2] \times [0, 1]$$

Solution

Just to make the point that order doesn't matter let's use a different order from that listed above. We'll do the integral in the following order.

$$\begin{aligned} \iiint_B 8xyz dV &= \int_1^2 \int_2^3 \int_0^1 8xyz dz dx dy \\ &= \int_1^2 \int_2^3 4xyz^2 \Big|_0^1 dx dy \\ &= \int_1^2 \int_2^3 4xy dx dy \\ &= \int_1^2 2x^2 y \Big|_2^3 dy \\ &= \int_1^2 10y dy = 15 \end{aligned}$$

Before moving on to more general regions let's get a nice geometric interpretation about the triple integral out of the way so we can use it in some of the examples to follow.

Fact

The volume of the three-dimensional region E is given by the integral,

$$V = \iiint_E dV$$

Let's now move on the more general three-dimensional regions. We have three different possibilities for a general region. Here is a sketch of the first possibility.

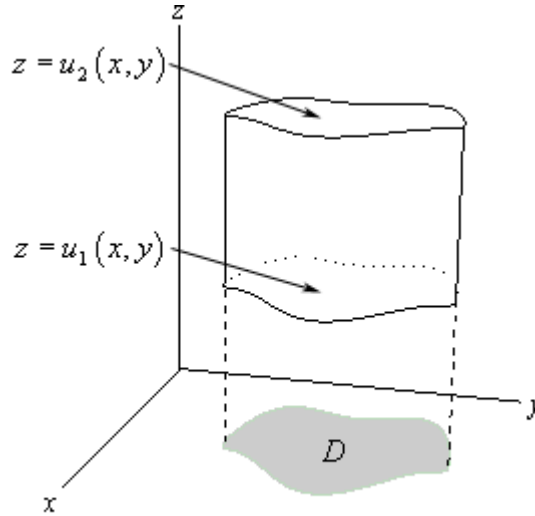

In this case we define the region E as follows,

$$E = \{(x, y, z) \mid (x, y) \in D, u_1(x, y) \leq z \leq u_2(x, y)\}$$

where $(x, y) \in D$ is the notation that means that the point (x, y) lies in the region D from the xy -plane. In this case we will evaluate the triple integral as follows,

$$\iiint_E f(x, y, z) dV = \iint_D \left[\int_{u_1(x, y)}^{u_2(x, y)} f(x, y, z) dz \right] dA$$

where the double integral can be evaluated in any of the methods that we saw in the previous couple of sections. In other words, we can integrate first with respect to x , we can integrate first with respect to y , or we can use polar coordinates as needed.

Example 2 Evaluate $\iiint_E 2x dV$ where E is the region under the plane $2x + 3y + z = 6$ that lies in the first octant.

Solution

We should first define *octant*. Just as the two-dimensional coordinates system can be divided into four quadrants the three-dimensional coordinate system can be divided into eight octants. The first octant is the octant in which all three of the coordinates are positive.

Here is a sketch of the plane in the first octant.

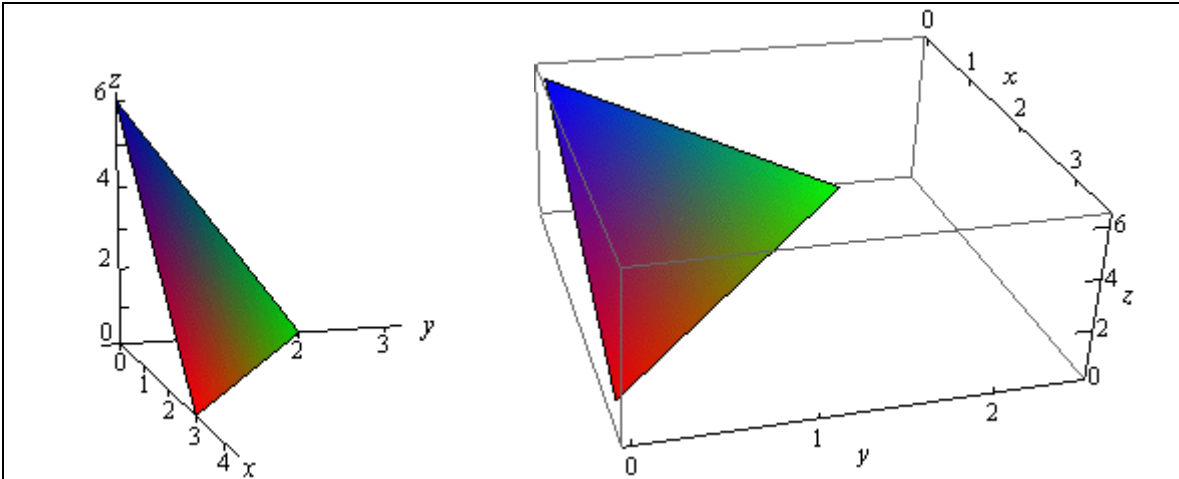

We now need to determine the region D in the xy -plane. We can get a visualization of the region by pretending to look straight down on the object from above. What we see will be the region D in the xy -plane. So D will be the triangle with vertices at $(0,0)$, $(3,0)$, and $(0,2)$. Here is a sketch of D .

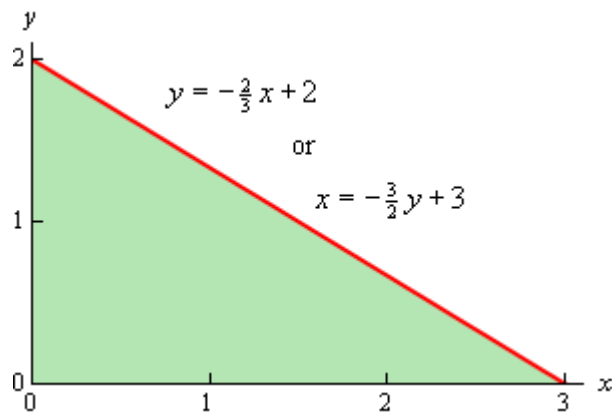

Now we need the limits of integration. Since we are under the plane and in the first octant (so we're above the plane $z = 0$) we have the following limits for z .

$$0 \leq z \leq 6 - 2x - 3y$$

We can integrate the double integral over D using either of the following two sets of inequalities.

$$\begin{array}{l|l} 0 \leq x \leq 3 & 0 \leq x \leq -\frac{3}{2}y + 3 \\ 0 \leq y \leq -\frac{2}{3}x + 2 & 0 \leq y \leq 2 \end{array}$$

Since neither really holds an advantage over the other we'll use the first one. The integral is then,

$$\begin{aligned}
 \iiint_E 2x \, dV &= \iint_D \left[\int_0^{6-2x-3y} 2x \, dz \right] dA \\
 &= \iint_D 2xz \Big|_0^{6-2x-3y} dA \\
 &= \int_0^3 \int_0^{\frac{2}{3}x+2} 2x(6-2x-3y) \, dy \, dx \\
 &= \int_0^3 \left(12xy - 4x^2y - 3xy^2 \right) \Big|_0^{\frac{2}{3}x+2} dx \\
 &= \int_0^3 \frac{4}{3}x^3 - 8x^2 + 12x \, dx \\
 &= \left(\frac{1}{3}x^4 - \frac{8}{3}x^3 + 6x^2 \right) \Big|_0^3 \\
 &= 9
 \end{aligned}$$

Let's now move onto the second possible three-dimensional region we may run into for triple integrals. Here is a sketch of this region.

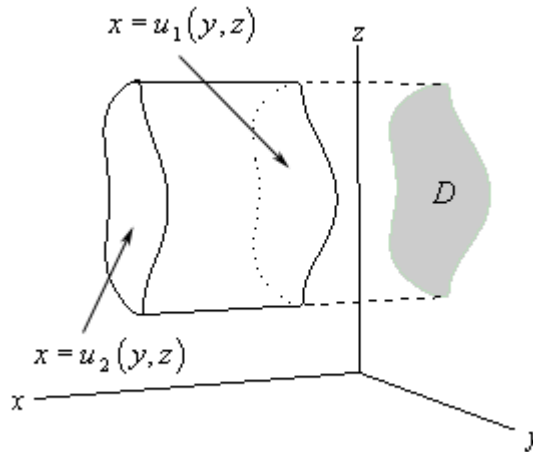

For this possibility we define the region E as follows,

$$E = \{(x, y, z) \mid (y, z) \in D, u_1(y, z) \leq x \leq u_2(y, z)\}$$

So, the region D will be a region in the yz -plane. Here is how we will evaluate these integrals.

$$\iiint_E f(x, y, z) \, dV = \iint_D \left[\int_{u_1(y,z)}^{u_2(y,z)} f(x, y, z) \, dx \right] dA$$

As with the first possibility we will have two options for doing the double integral in the yz -plane as well as the option of using polar coordinates if needed.

Example 3 Determine the volume of the region that lies behind the plane $x + y + z = 8$ and in front of the region in the yz -plane that is bounded by $z = \frac{3}{2}\sqrt{y}$ and $z = \frac{3}{4}y$.

Solution

In this case we've been given D and so we won't have to really work to find that. Here is a sketch of the region D as well as a quick sketch of the plane and the curves defining D projected out past the plane so we can get an idea of what the region we're dealing with looks like.

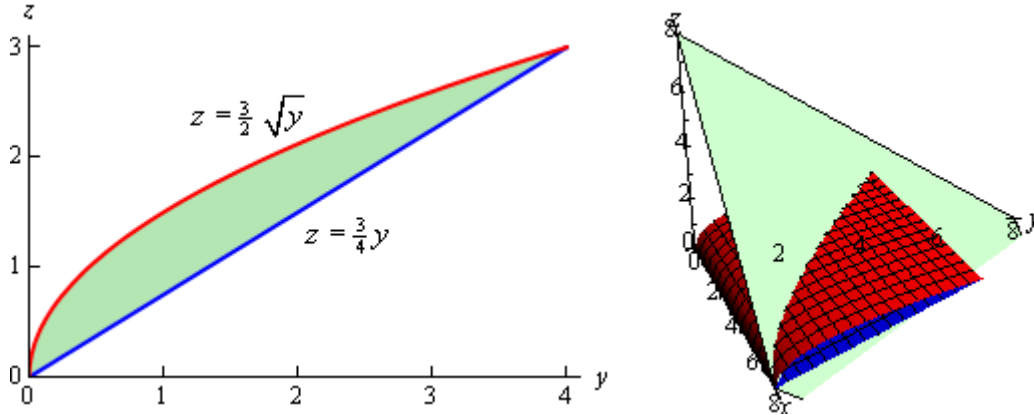

Now, the graph of the region above is all okay, but it doesn't really show us what the region is. So, here is a sketch of the region itself.

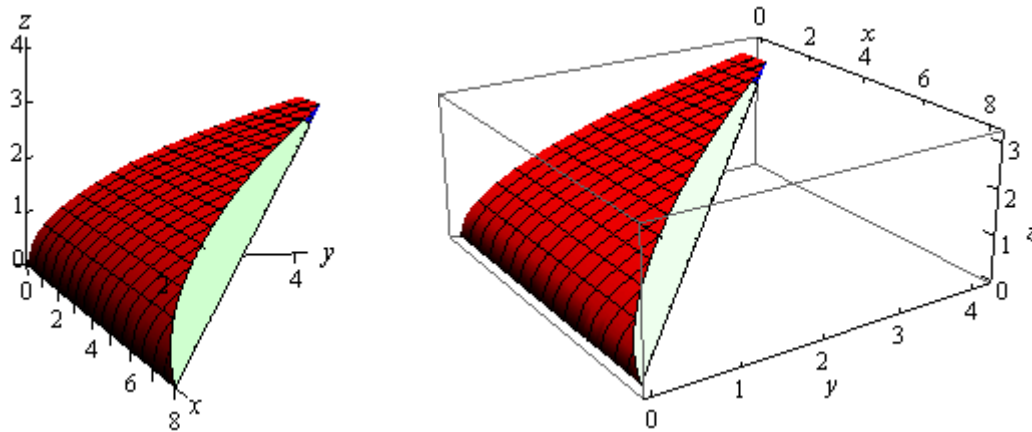

Here are the limits for each of the variables.

$$0 \leq y \leq 4$$

$$\frac{3}{4}y \leq z \leq \frac{3}{2}\sqrt{y}$$

$$0 \leq x \leq 8 - y - z$$

The volume is then,

$$\begin{aligned}
 V &= \iiint_E dV = \iint_D \left[\int_0^{8-y-z} dx \right] dA \\
 &= \int_0^4 \int_{3y/4}^{3\sqrt{y}/2} 8 - y - z \, dz \, dy \\
 &= \int_0^4 \left(8z - yz - \frac{1}{2} z^2 \right) \Big|_{\frac{3y}{4}}^{\frac{3\sqrt{y}}{2}} dy \\
 &= \int_0^4 12y^{\frac{1}{2}} - \frac{57}{8}y - \frac{3}{2}y^{\frac{3}{2}} + \frac{33}{32}y^2 \, dy \\
 &= \left(8y^{\frac{3}{2}} - \frac{57}{16}y^2 - \frac{3}{5}y^{\frac{5}{2}} + \frac{11}{32}y^3 \right) \Big|_0^4 = \frac{49}{5}
 \end{aligned}$$

We now need to look at the third (and final) possible three-dimensional region we may run into for triple integrals. Here is a sketch of this region.

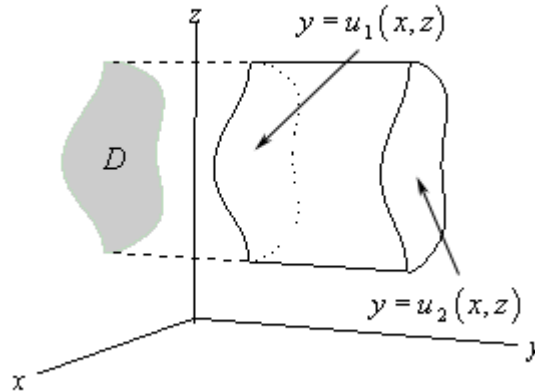

In this final case E is defined as,

$$E = \{(x, y, z) \mid (x, z) \in D, u_1(x, z) \leq y \leq u_2(x, z)\}$$

and here the region D will be a region in the xz -plane. Here is how we will evaluate these integrals.

$$\iiint_E f(x, y, z) dV = \iint_D \left[\int_{u_1(x,z)}^{u_2(x,z)} f(x, y, z) dy \right] dA$$

where we will can use either of the two possible orders for integrating D in the xz -plane or we can use polar coordinates if needed.

Example 4 Evaluate $\iiint_E \sqrt{3x^2 + 3z^2} \, dV$ where E is the solid bounded by $y = 2x^2 + 2z^2$ and the plane $y = 8$.

Solution

Here is a sketch of the solid E .

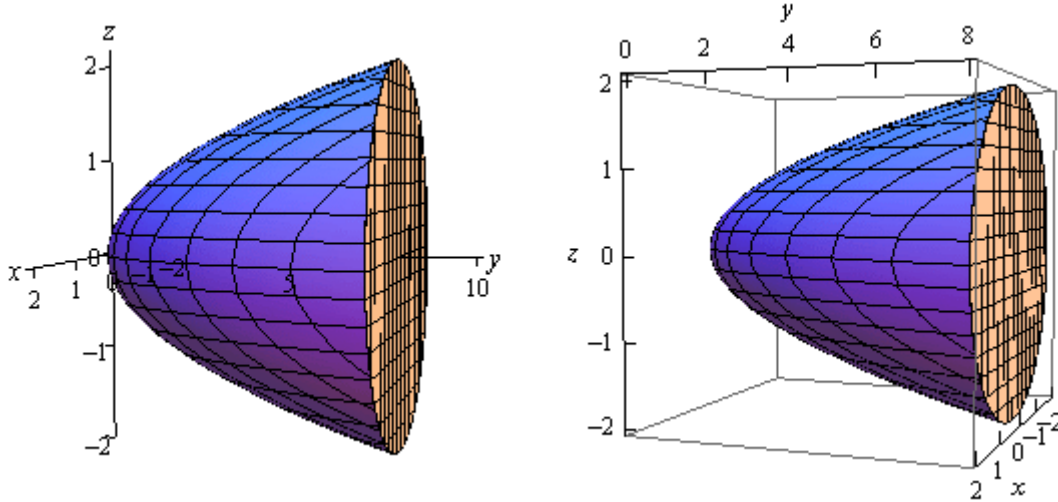

The region D in the xz -plane can be found by “standing” in front of this solid and we can see that D will be a disk in the xz -plane. This disk will come from the front of the solid and we can determine the equation of the disk by setting the elliptic paraboloid and the plane equal.

$$2x^2 + 2z^2 = 8 \quad \Rightarrow \quad x^2 + z^2 = 4$$

This region, as well as the integrand, both seems to suggest that we should use something like polar coordinates. However we are in the xz -plane and we’ve only seen polar coordinates in the xy -plane. This is not a problem. We can always “translate” them over to the xz -plane with the following definition.

$$x = r \cos \theta \qquad z = r \sin \theta$$

Since the region doesn’t have y ’s we will let z take the place of y in all the formulas. Note that these definitions also lead to the formula,

$$x^2 + z^2 = r^2$$

With this in hand we can arrive at the limits of the variables that we’ll need for this integral.

$$2x^2 + 2z^2 \leq y \leq 8$$

$$0 \leq r \leq 2$$

$$0 \leq \theta \leq 2\pi$$

The integral is then,

$$\begin{aligned}
\iiint_E \sqrt{3x^2 + 3z^2} \, dV &= \iint_D \left[\int_{2x^2+2z^2}^8 \sqrt{3x^2 + 3z^2} \, dy \right] dA \\
&= \iint_D \left(y\sqrt{3x^2 + 3z^2} \right) \Big|_{2x^2+2z^2}^8 dA \\
&= \iint_D \sqrt{3(x^2 + z^2)} (8 - (2x^2 + 2z^2)) dA
\end{aligned}$$

Now, since we are going to do the double integral in polar coordinates let's get everything converted over to polar coordinates. The integrand is,

$$\begin{aligned}
\sqrt{3(x^2 + z^2)} (8 - (2x^2 + 2z^2)) &= \sqrt{3r^2} (8 - 2r^2) \\
&= \sqrt{3} r (8 - 2r^2) \\
&= \sqrt{3} (8r - 2r^3)
\end{aligned}$$

The integral is then,

$$\begin{aligned}
\iiint_E \sqrt{3x^2 + 3z^2} \, dV &= \iint_D \sqrt{3} (8r - 2r^3) dA \\
&= \sqrt{3} \int_0^{2\pi} \int_0^2 (8r - 2r^3) r \, dr \, d\theta \\
&= \sqrt{3} \int_0^{2\pi} \left(\frac{8}{3} r^3 - \frac{2}{5} r^5 \right) \Big|_0^2 d\theta \\
&= \sqrt{3} \int_0^{2\pi} \frac{128}{15} d\theta \\
&= \frac{256\sqrt{3} \pi}{15}
\end{aligned}$$

Triple Integrals in Cylindrical Coordinates

In this section we want to take a look at triple integrals done completely in Cylindrical Coordinates. [Recall](#) that cylindrical coordinates are really nothing more than an extension of polar coordinates into three dimensions. The following are the conversion formulas for cylindrical coordinates.

$$x = r \cos \theta \quad y = r \sin \theta \quad z = z$$

In order to do the integral in cylindrical coordinates we will need to know what dV will become in terms of cylindrical coordinates. We will be able to show in the [Change of Variables](#) section of this chapter that,

$$dV = r \, dz \, dr \, d\theta$$

The region, E , over which we are integrating becomes,

$$\begin{aligned} E &= \{(x, y, z) \mid (x, y) \in D, u_1(x, y) \leq z \leq u_2(x, y)\} \\ &= \{(r, \theta, z) \mid \alpha \leq \theta \leq \beta, h_1(\theta) \leq r \leq h_2(\theta), u_1(r \cos \theta, r \sin \theta) \leq z \leq u_2(r \cos \theta, r \sin \theta)\} \end{aligned}$$

Note that we've only given this for E 's in which D is in the xy -plane. We can modify this accordingly if D is in the yz -plane or the xz -plane as needed.

In terms of cylindrical coordinates a triple integral is,

$$\iiint_E f(x, y, z) \, dV = \int_{\alpha}^{\beta} \int_{h_1(\theta)}^{h_2(\theta)} \int_{u_1(r \cos \theta, r \sin \theta)}^{u_2(r \cos \theta, r \sin \theta)} r f(r \cos \theta, r \sin \theta, z) \, dz \, dr \, d\theta$$

Don't forget to add in the r and make sure that all the x 's and y 's also get converted over into cylindrical coordinates.

Let's see an example.

Example 1 Evaluate $\iiint_E y \, dV$ where E is the region that lies below the plane $z = x + 2$ above the xy -plane and between the cylinders $x^2 + y^2 = 1$ and $x^2 + y^2 = 4$.

Solution

There really isn't too much to do with this one other than do the conversions and then evaluate the integral.

We'll start out by getting the range for z in terms of cylindrical coordinates.

$$0 \leq z \leq x + 2 \quad \Rightarrow \quad 0 \leq z \leq r \cos \theta + 2$$

Remember that we are above the xy -plane and so we are above the plane $z = 0$

Next, the region D is the region between the two circles $x^2 + y^2 = 1$ and $x^2 + y^2 = 4$ in the xy -plane and so the ranges for it are,

$$0 \leq \theta \leq 2\pi \quad 1 \leq r \leq 2$$

Here is the integral.

$$\begin{aligned}
 \iiint_E y \, dV &= \int_0^{2\pi} \int_1^2 \int_0^{r \cos \theta + 2} (r \sin \theta) r \, dz \, dr \, d\theta \\
 &= \int_0^{2\pi} \int_1^2 r^2 \sin \theta (r \cos \theta + 2) \, dr \, d\theta \\
 &= \int_0^{2\pi} \int_1^2 \frac{1}{2} r^3 \sin(2\theta) + 2r^2 \sin \theta \, dr \, d\theta \\
 &= \int_0^{2\pi} \left(\frac{1}{8} r^4 \sin(2\theta) + \frac{2}{3} r^3 \sin \theta \right) \Big|_1^2 \, d\theta \\
 &= \int_0^{2\pi} \frac{15}{8} \sin(2\theta) + \frac{14}{3} \sin \theta \, d\theta \\
 &= \left(-\frac{15}{16} \cos(2\theta) - \frac{14}{3} \cos \theta \right) \Big|_0^{2\pi} \\
 &= 0
 \end{aligned}$$

Just as we did with double integral involving polar coordinates we can start with an iterated integral in terms of x , y , and z and convert it to cylindrical coordinates.

Example 2 Convert $\int_{-1}^1 \int_0^{\sqrt{1-y^2}} \int_{x^2+y^2}^{\sqrt{x^2+y^2}} xyz \, dz \, dx \, dy$ into an integral in cylindrical coordinates.

Solution

Here are the ranges of the variables from this iterated integral.

$$\begin{aligned}
 -1 &\leq y \leq 1 \\
 0 &\leq x \leq \sqrt{1-y^2} \\
 x^2 + y^2 &\leq z \leq \sqrt{x^2 + y^2}
 \end{aligned}$$

The first two inequalities define the region D and since the upper and lower bounds for the x 's are $x = \sqrt{1-y^2}$ and $x = 0$ we know that we've got at least part of the right half a circle of radius 1 centered at the origin. Since the range of y 's is $-1 \leq y \leq 1$ we know that we have the complete right half of the disk of radius 1 centered at the origin. So, the ranges for D in cylindrical coordinates are,

$$\begin{aligned}
 -\frac{\pi}{2} &\leq \theta \leq \frac{\pi}{2} \\
 0 &\leq r \leq 1
 \end{aligned}$$

All that's left to do now is to convert the limits of the z range, but that's not too bad.

$$r^2 \leq z \leq r$$

On a side note notice that the lower bound here is an elliptic paraboloid and the upper bound is a cone. Therefore E is a portion of the region between these two surfaces.

The integral is,

$$\begin{aligned}\int_{-1}^1 \int_0^{\sqrt{1-y^2}} \int_{x^2+y^2}^{\sqrt{x^2+y^2}} xyz \, dz \, dx \, dy &= \int_{-\pi/2}^{\pi/2} \int_0^1 \int_{r^2}^r r(r \cos \theta)(r \sin \theta) z \, dz \, dr \, d\theta \\ &= \int_{-\pi/2}^{\pi/2} \int_0^1 \int_{r^2}^r zr^3 \cos \theta \sin \theta \, dz \, dr \, d\theta\end{aligned}$$

Triple Integrals in Spherical Coordinates

In the previous section we looked at doing integrals in terms of cylindrical coordinates and we now need to take a quick look at doing integrals in terms of spherical coordinates.

First, we need to [recall](#) just how spherical coordinates are defined. The following sketch shows the relationship between the Cartesian and spherical coordinate systems.

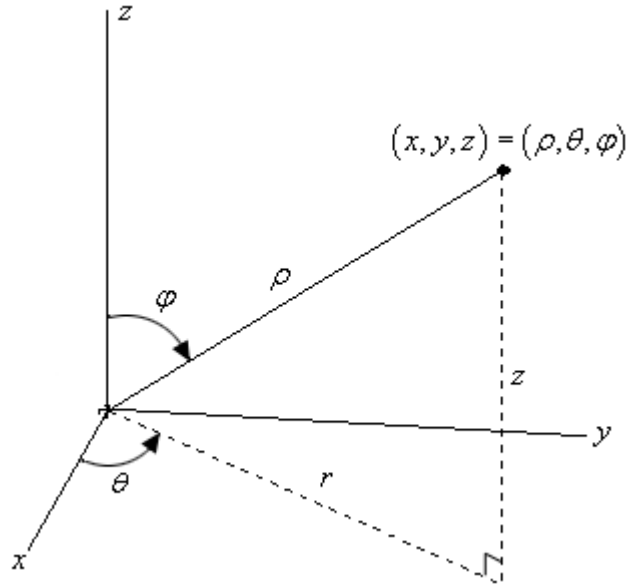

Here are the conversion formulas for spherical coordinates.

$$x = \rho \sin \varphi \cos \theta \quad y = \rho \sin \varphi \sin \theta \quad z = \rho \cos \varphi$$

$$x^2 + y^2 + z^2 = \rho^2$$

We also have the following restrictions on the coordinates.

$$\rho \geq 0 \quad 0 \leq \varphi \leq \pi$$

For our integrals we are going to restrict E down to a spherical wedge. This will mean that we are going to take ranges for the variables as follows,

$$a \leq \rho \leq b$$

$$\alpha \leq \theta \leq \beta$$

$$\delta \leq \varphi \leq \gamma$$

Here is a quick sketch of a spherical wedge in which the lower limit for both ρ and φ are zero for reference purposes. Most of the wedges we'll be working with will fit into this pattern.

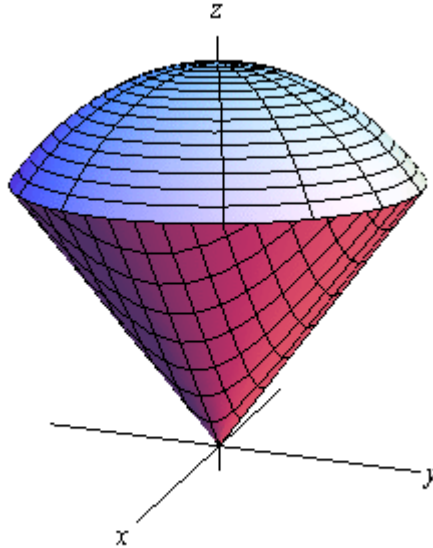

From this sketch we can see that E is really nothing more than the intersection of a sphere and a cone.

In the next [section](#) we will show that

$$dV = \rho^2 \sin \varphi d\rho d\theta d\varphi$$

Therefore the integral will become,

$$\iiint_E f(x, y, z) dV = \int_{\delta}^{\gamma} \int_{\alpha}^{\beta} \int_a^b \rho^2 \sin \varphi f(\rho \sin \varphi \cos \theta, \rho \sin \varphi \sin \theta, \rho \cos \varphi) d\rho d\theta d\varphi$$

This looks bad, but given that the limits are all constants the integrals here tend to not be too bad.

Example 1 Evaluate $\iiint_E 16z dV$ where E is the upper half of the sphere $x^2 + y^2 + z^2 = 1$.

Solution

Since we are taking the upper half of the sphere the limits for the variables are,

$$0 \leq \rho \leq 1$$

$$0 \leq \theta \leq 2\pi$$

$$0 \leq \varphi \leq \frac{\pi}{2}$$

The integral is then,

$$\begin{aligned}
\iiint_E 16z \, dV &= \int_0^{\frac{\pi}{2}} \int_0^{2\pi} \int_0^1 \rho^2 \sin \varphi (16\rho \cos \varphi) \, d\rho \, d\theta \, d\varphi \\
&= \int_0^{\frac{\pi}{2}} \int_0^{2\pi} \int_0^1 8\rho^3 \sin(2\varphi) \, d\rho \, d\theta \, d\varphi \\
&= \int_0^{\frac{\pi}{2}} \int_0^{2\pi} 2 \sin(2\varphi) \, d\theta \, d\varphi \\
&= \int_0^{\frac{\pi}{2}} 4\pi \sin(2\varphi) \, d\varphi \\
&= -2\pi \cos(2\varphi) \Big|_0^{\frac{\pi}{2}} \\
&= 4\pi
\end{aligned}$$

Example 2 Convert $\int_0^3 \int_0^{\sqrt{9-y^2}} \int_{\sqrt{x^2+y^2}}^{\sqrt{18-x^2-y^2}} x^2 + y^2 + z^2 \, dz \, dx \, dy$ into spherical coordinates.

Solution

Let's first write down the limits for the variables.

$$\begin{aligned}
0 &\leq y \leq 3 \\
0 &\leq x \leq \sqrt{9-y^2} \\
\sqrt{x^2+y^2} &\leq z \leq \sqrt{18-x^2-y^2}
\end{aligned}$$

The range for x tells us that we have a portion of the right half of a disk of radius 3 centered at the origin. Since we are restricting y 's to positive values it looks like we will have the quarter disk in the first quadrant. Therefore since D is in the first quadrant the region, E , must be in the first octant and this in turn tells us that we have the following range for θ (since this is the angle around the z -axis).

$$0 \leq \theta \leq \frac{\pi}{2}$$

Now, let's see what the range for z tells us. The lower bound, $z = \sqrt{x^2 + y^2}$, is the upper half of a cone. At this point we don't need this quite yet, but we will later. The upper bound,

$z = \sqrt{18 - x^2 - y^2}$, is the upper half of the sphere,

$$x^2 + y^2 + z^2 = 18$$

and so from this we now have the following range for ρ

$$0 \leq \rho \leq \sqrt{18} = 3\sqrt{2}$$

Now all that we need is the range for φ . There are two ways to get this. One is from where the cone and the sphere intersect. Plugging in the equation for the cone into the sphere gives,

$$\left(\sqrt{x^2 + y^2}\right)^2 + z^2 = 18$$

$$z^2 + z^2 = 18$$

$$z^2 = 9$$

$$z = 3$$

Note that we can assume z is positive here since we know that we have the upper half of the cone and/or sphere. Finally, plug this into the conversion for z and take advantage of the fact that we know that $\rho = 3\sqrt{2}$ since we are intersecting on the sphere. This gives,

$$\rho \cos \varphi = 3$$

$$3\sqrt{2} \cos \varphi = 3$$

$$\cos \varphi = \frac{1}{\sqrt{2}} = \frac{\sqrt{2}}{2} \quad \Rightarrow \quad \varphi = \frac{\pi}{4}$$

So, it looks like we have the following range,

$$0 \leq \varphi \leq \frac{\pi}{4}$$

The other way to get this range is from the cone by itself. By first converting the equation into cylindrical coordinates and then into spherical coordinates we get the following,

$$z = r$$

$$\rho \cos \varphi = \rho \sin \varphi$$

$$1 = \tan \varphi \quad \Rightarrow \quad \varphi = \frac{\pi}{4}$$

So, recalling that $\rho^2 = x^2 + y^2 + z^2$, the integral is then,

$$\int_0^3 \int_0^{\sqrt{9-y^2}} \int_{\sqrt{x^2+y^2}}^{\sqrt{18-x^2-y^2}} x^2 + y^2 + z^2 \, dz \, dx \, dy = \int_0^{\pi/4} \int_0^{\pi/2} \int_0^{3\sqrt{2}} \rho^4 \sin \varphi \, d\rho \, d\theta \, d\varphi$$

Change of Variables

Back in Calculus I we had the substitution rule that told us that,

$$\int_a^b f(g(x))g'(x)dx = \int_c^d f(u)du \quad \text{where } u = g(x)$$

In essence this is taking an integral in terms of x 's and changing it into terms of u 's. We want to do something similar for double and triple integrals. In fact we've already done this to a certain extent when we converted double integrals to polar coordinates and when we converted triple integrals to cylindrical or spherical coordinates. The main difference is that we didn't actually go through the details of where the formulas came from. If you recall, in each of those cases we commented that we would justify the formulas for dA and dV eventually. Now is the time to do that justification.

While often the reason for changing variables is to get us an integral that we can do with the new variables, another reason for changing variables is to convert the region into a nicer region to work with. When we were converting the polar, cylindrical or spherical coordinates we didn't worry about this change since it was easy enough to determine the new limits based on the given region. That is not always the case however. So, before we move into changing variables with multiple integrals we first need to see how the region may change with a change of variables.

First we need a little notation out of the way. We call the equations that define the change of variables a **transformation**. Also we will typically start out with a region, R , in xy -coordinates and transform it into a region in uv -coordinates.

Example 1 Determine the new region that we get by applying the given transformation to the region R .

(a) R is the ellipse $x^2 + \frac{y^2}{36} = 1$ and the transformation is $x = \frac{u}{2}$, $y = 3v$. [\[Solution\]](#)

(b) R is the region bounded by $y = -x + 4$, $y = x + 1$, and $y = \frac{x}{3} - \frac{4}{3}$ and the

transformation is $x = \frac{1}{2}(u + v)$, $y = \frac{1}{2}(u - v)$. [\[Solution\]](#)

Solution

(a) **R is the ellipse $x^2 + \frac{y^2}{36} = 1$ and the transformation is $x = \frac{u}{2}$, $y = 3v$.**

There really isn't too much to do with this one other than to plug the transformation into the equation for the ellipse and see what we get.

$$\begin{aligned} \left(\frac{u}{2}\right)^2 + \frac{(3v)^2}{36} &= 1 \\ \frac{u^2}{4} + \frac{9v^2}{36} &= 1 \\ u^2 + v^2 &= 4 \end{aligned}$$

So, we started out with an ellipse and after the transformation we had a disk of radius 2.

[\[Return to Problems\]](#)

(b) R is the region bounded by $y = -x + 4$, $y = x + 1$, and $y = \frac{x}{3} - \frac{4}{3}$ and the

transformation is $x = \frac{1}{2}(u + v)$, $y = \frac{1}{2}(u - v)$.

As with the first part we'll need to plug the transformation into the equation, however, in this case we will need to do it three times, once for each equation. Before we do that let's sketch the graph of the region and see what we've got.

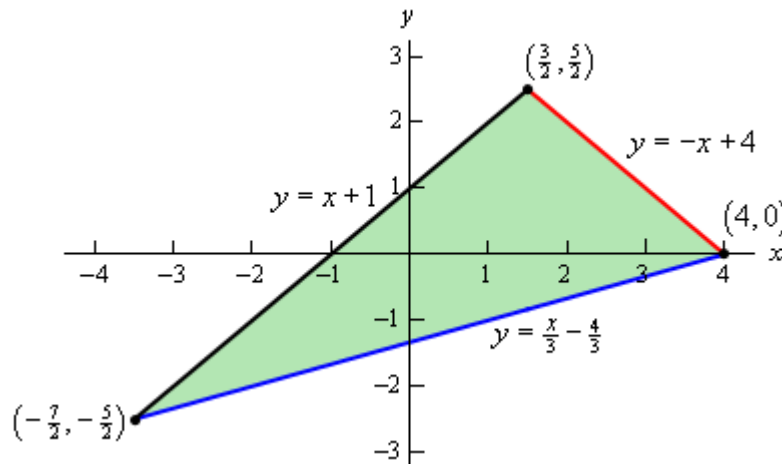

So, we have a triangle. Now, let's go through the transformation. We will apply the transformation to each edge of the triangle and see where we get.

Let's do $y = -x + 4$ first. Plugging in the transformation gives,

$$\frac{1}{2}(u - v) = -\frac{1}{2}(u + v) + 4$$

$$u - v = -u - v + 8$$

$$2u = 8$$

$$u = 4$$

The first boundary transforms very nicely into a much simpler equation.

Now let's take a look at $y = x + 1$,

$$\frac{1}{2}(u - v) = \frac{1}{2}(u + v) + 1$$

$$u - v = u + v + 2$$

$$-2v = 2$$

$$v = -1$$

Again, a much nicer equation than what we started with.

Finally, let's transform $y = \frac{x}{3} - \frac{4}{3}$.

$$\frac{1}{2}(u - v) = \frac{1}{3}\left(\frac{1}{2}(u + v)\right) - \frac{4}{3}$$

$$3u - 3v = u + v - 8$$

$$4v = 2u + 8$$

$$v = \frac{u}{2} + 2$$

So, again, we got a somewhat simpler equation, although not quite as nice as the first two.

Let's take a look at the new region that we get under the transformation.

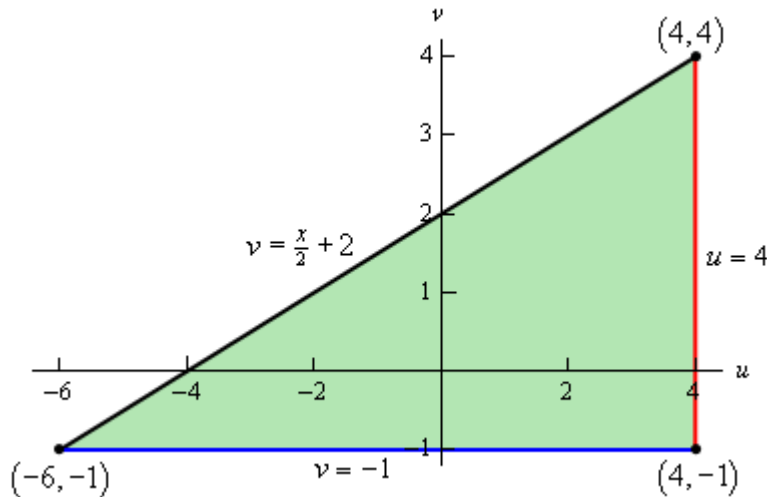

We still get a triangle, but a much nicer one.

[\[Return to Problems\]](#)

Note that we can't always expect to transform a specific type of region (a triangle for example) into the same kind of region. It is completely possible to have a triangle transform into a region in which each of the edges are curved and in no way resembles a triangle.

Notice that in each of the above examples we took a two dimensional region that would have been somewhat difficult to integrate over and converted it into a region that would be much nicer in integrate over. As we noted at the start of this set of examples, that is often one of the points behind the transformation. In addition to converting the integrand into something simpler it will often also transform the region into one that is much easier to deal with.

Now that we've seen a couple of examples of transforming regions we need to now talk about how we actually do change of variables in the integral. We will start with double integrals. In order to change variables in a double integral we will need the **Jacobian** of the transformation. Here is the definition of the Jacobian.

Definition

The **Jacobian** of the transformation $x = g(u, v)$, $y = h(u, v)$ is

$$\frac{\partial(x, y)}{\partial(u, v)} = \begin{vmatrix} \frac{\partial x}{\partial u} & \frac{\partial x}{\partial v} \\ \frac{\partial y}{\partial u} & \frac{\partial y}{\partial v} \end{vmatrix}$$

The Jacobian is defined as a determinant of a 2x2 matrix, if you are unfamiliar with this that is okay. Here is how to compute the determinant.

$$\begin{vmatrix} a & b \\ c & d \end{vmatrix} = ad - bc$$

Therefore, another formula for the determinant is,

$$\frac{\partial(x, y)}{\partial(u, v)} = \begin{vmatrix} \frac{\partial x}{\partial u} & \frac{\partial x}{\partial v} \\ \frac{\partial y}{\partial u} & \frac{\partial y}{\partial v} \end{vmatrix} = \frac{\partial x}{\partial u} \frac{\partial y}{\partial v} - \frac{\partial x}{\partial v} \frac{\partial y}{\partial u}$$

Now that we have the Jacobian out of the way we can give the formula for change of variables for a double integral.

Change of Variables for a Double Integral

Suppose that we want to integrate $f(x, y)$ over the region R . Under the transformation $x = g(u, v)$, $y = h(u, v)$ the region becomes S and the integral becomes,

$$\iint_D f(x, y) dA = \iint_S f(g(u, v), h(u, v)) \left| \frac{\partial(x, y)}{\partial(u, v)} \right| du dv$$

Note that we used $du dv$ instead of dA in the integral to make it clear that we are now integrating with respect to u and v . Also note that we are taking the absolute value of the Jacobian.

If we look just at the differentials in the above formula we can also say that

$$dA = \left| \frac{\partial(x, y)}{\partial(u, v)} \right| du dv$$

Example 2 Show that when changing to polar coordinates we have $dA = r dr d\theta$

Solution

So, what we are doing here is justifying the formula that we used back when we were integrating with respect to [polar coordinates](#). All that we need to do is use the formula above for dA .

The transformation here is the standard conversion formulas,

$$x = r \cos \theta \qquad y = r \sin \theta$$

The Jacobian for this transformation is,

$$\begin{aligned} \frac{\partial(x, y)}{\partial(r, \theta)} &= \begin{vmatrix} \frac{\partial x}{\partial r} & \frac{\partial x}{\partial \theta} \\ \frac{\partial y}{\partial r} & \frac{\partial y}{\partial \theta} \end{vmatrix} \\ &= \begin{vmatrix} \cos \theta & -r \sin \theta \\ \sin \theta & r \cos \theta \end{vmatrix} \\ &= r \cos^2 \theta - (-r \sin^2 \theta) \\ &= r(\cos^2 \theta + \sin^2 \theta) \\ &= r \end{aligned}$$

We then get,

$$dA = \left| \frac{\partial(x, y)}{\partial(r, \theta)} \right| dr d\theta = |r| dr d\theta = r dr d\theta$$

So, the formula we used in the section on polar integrals was correct.

Now, let's do a couple of integrals.

Example 3 Evaluate $\iint_R x + y dA$ where R is the trapezoidal region with vertices given by $(0, 0)$, $(5, 0)$, $(\frac{5}{2}, \frac{5}{2})$ and $(\frac{5}{2}, -\frac{5}{2})$ using the transformation $x = 2u + 3v$ and $y = 2u - 3v$.

Solution

First, let's sketch the region R and determine equations for each of the sides.

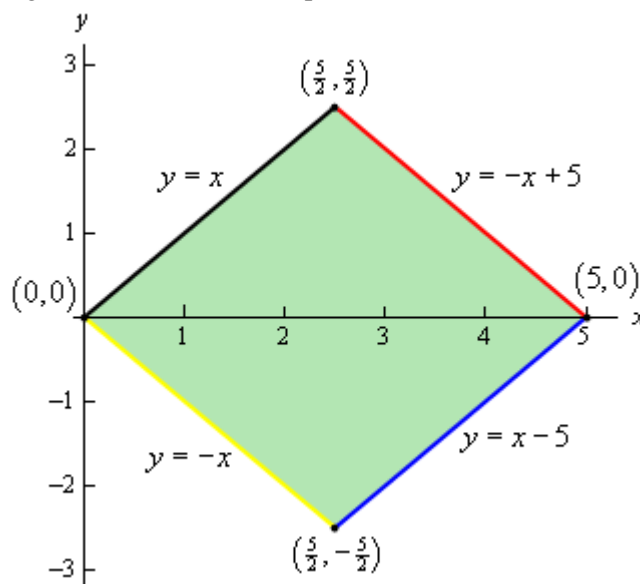

Each of the equations was found by using the fact that we know two points on each line (*i.e.* the two vertices that form the edge).

While we could do this integral in terms of x and y it would involve two integrals and so would be some work.

Let's use the transformation and see what we get. We'll do this by plugging the transformation into each of the equations above.

Let's start the process off with $y = x$.

$$2u - 3v = 2u + 3v$$

$$6v = 0$$

$$v = 0$$

Transforming $y = -x$ is similar.

$$2u - 3v = -(2u + 3v)$$

$$4u = 0$$

$$u = 0$$

Next we'll transform $y = -x + 5$.

$$2u - 3v = -(2u + 3v) + 5$$

$$4u = 5$$

$$u = \frac{5}{4}$$

Finally, let's transform $y = x - 5$.

$$2u - 3v = 2u + 3v - 5$$

$$-6v = -5$$

$$v = \frac{5}{6}$$

The region S is then a rectangle whose sides are given by $u = 0$, $v = 0$, $u = \frac{5}{4}$ and $v = \frac{5}{6}$ and so the ranges of u and v are,

$$0 \leq u \leq \frac{5}{4} \qquad 0 \leq v \leq \frac{5}{6}$$

Next, we need the Jacobian.

$$\frac{\partial(x, y)}{\partial(u, v)} = \begin{vmatrix} 2 & 3 \\ 2 & -3 \end{vmatrix} = -6 - 6 = -12$$

The integral is then,

$$\begin{aligned}
\iint_R x + y \, dA &= \int_0^{\frac{5}{6}} \int_0^{\frac{5}{4}} ((2u + 3v) + (2u - 3v)) | -12 | \, du \, dv \\
&= \int_0^{\frac{5}{6}} \int_0^{\frac{5}{4}} 48u \, du \, dv \\
&= \int_0^{\frac{5}{6}} 24u^2 \Big|_0^{\frac{5}{4}} \, dv \\
&= \int_0^{\frac{5}{6}} \frac{75}{2} \, dv \\
&= \frac{75}{2} v \Big|_0^{\frac{5}{6}} \\
&= \frac{125}{4}
\end{aligned}$$

Example 4 Evaluate $\iint_R x^2 - xy + y^2 \, dA$ where R is the ellipse given by $x^2 - xy + y^2 = 2$ and

using the transformation $x = \sqrt{2}u - \sqrt{\frac{2}{3}}v$, $y = \sqrt{2}u + \sqrt{\frac{2}{3}}v$.

Solution

The first thing to do is to plug the transformation into the equation for the ellipse to see what the region transforms into.

$$\begin{aligned}
2 &= x^2 - xy + y^2 \\
&= \left(\sqrt{2}u - \sqrt{\frac{2}{3}}v \right)^2 - \left(\sqrt{2}u - \sqrt{\frac{2}{3}}v \right) \left(\sqrt{2}u + \sqrt{\frac{2}{3}}v \right) + \left(\sqrt{2}u + \sqrt{\frac{2}{3}}v \right)^2 \\
&= 2u^2 - \frac{4}{\sqrt{3}}uv + \frac{2}{3}v^2 - \left(2u^2 - \frac{2}{3}v^2 \right) + 2u^2 + \frac{4}{\sqrt{3}}uv + \frac{2}{3}v^2 \\
&= 2u^2 + 2v^2
\end{aligned}$$

Or, upon dividing by 2 we see that the equation describing R transforms into

$$u^2 + v^2 = 1$$

or the unit circle. Again, this will be much easier to integrate over than the original region.

Note as well that we've shown that the function that we're integrating is

$$x^2 - xy + y^2 = 2(u^2 + v^2)$$

in terms of u and v so we won't have to redo that work when the time to do the integral comes around.

Finally, we need to find the Jacobian.

$$\frac{\partial(x, y)}{\partial(u, v)} = \begin{vmatrix} \sqrt{2} & -\sqrt{\frac{2}{3}} \\ \sqrt{2} & \sqrt{\frac{2}{3}} \end{vmatrix} = \frac{2}{\sqrt{3}} + \frac{2}{\sqrt{3}} = \frac{4}{\sqrt{3}}$$

The integral is then,

$$\iint_R x^2 - xy + y^2 dA = \iint_S 2(u^2 + v^2) \left| \frac{4}{\sqrt{3}} \right| du dv$$

Before proceeding a word of caution is in order. Do not make the mistake of substituting $x^2 - xy + y^2 = 2$ or $u^2 + v^2 = 1$ in for the integrands. These equations are only valid on the boundary of the region and we are looking at all the points interior to the boundary as well and for those points neither of these equations will be true!

At this point we'll note that this integral will be much easier in terms of polar coordinates and so to finish the integral out will convert to polar coordinates.

$$\begin{aligned} \iint_R x^2 - xy + y^2 dA &= \iint_S 2(u^2 + v^2) \left| \frac{4}{\sqrt{3}} \right| du dv \\ &= \frac{8}{\sqrt{3}} \int_0^{2\pi} \int_0^1 (r^2) r dr d\theta \\ &= \frac{8}{\sqrt{3}} \int_0^{2\pi} \frac{1}{4} r^4 \Big|_0^1 d\theta \\ &= \frac{8}{\sqrt{3}} \int_0^{2\pi} \frac{1}{4} d\theta \\ &= \frac{4\pi}{\sqrt{3}} \end{aligned}$$

Let's now briefly look at triple integrals. In this case we will again start with a region R and use the transformation $x = g(u, v, w)$, $y = h(u, v, w)$, and $z = k(u, v, w)$ to transform the region into the new region S . To do the integral we will need a Jacobian, just as we did with double integrals. Here is the definition of the Jacobian for this kind of transformation.

$$\frac{\partial(x, y, z)}{\partial(u, v, w)} = \begin{vmatrix} \frac{\partial x}{\partial u} & \frac{\partial x}{\partial v} & \frac{\partial x}{\partial w} \\ \frac{\partial y}{\partial u} & \frac{\partial y}{\partial v} & \frac{\partial y}{\partial w} \\ \frac{\partial z}{\partial u} & \frac{\partial z}{\partial v} & \frac{\partial z}{\partial w} \end{vmatrix}$$

In this case the Jacobian is defined in terms of the determinant of a 3x3 matrix. We saw how to evaluate these when we looked at [cross products](#) back in Calculus II. If you need a refresher on how to compute them you should go back and review that section.

The integral under this transformation is,

$$\iiint_R f(x, y, z) dV = \iiint_S f(g(u, v, w), h(u, v, w), k(u, v, w)) \left| \frac{\partial(x, y, z)}{\partial(u, v, w)} \right| du dv dw$$

As with double integrals we can look at just the differentials and note that we must have

$$dV = \left| \frac{\partial(x, y, z)}{\partial(u, v, w)} \right| du dv dw$$

We're not going to do any integrals here, but let's verify the formula for dV for spherical coordinates.

Example 5 Verify that $dV = \rho^2 \sin \varphi d\rho d\theta d\varphi$ when using spherical coordinates.

Solution

Here the transformation is just the standard conversion formulas.

$$x = \rho \sin \varphi \cos \theta \quad y = \rho \sin \varphi \sin \theta \quad z = \rho \cos \varphi$$

The Jacobian is,

$$\begin{aligned} \frac{\partial(x, y, z)}{\partial(\rho, \theta, \varphi)} &= \begin{vmatrix} \sin \varphi \cos \theta & -\rho \sin \varphi \sin \theta & \rho \cos \varphi \cos \theta \\ \sin \varphi \sin \theta & \rho \sin \varphi \cos \theta & \rho \cos \varphi \sin \theta \\ \cos \varphi & 0 & -\rho \sin \varphi \end{vmatrix} \\ &= -\rho^2 \sin^3 \varphi \cos^2 \theta - \rho^2 \sin \varphi \cos^2 \varphi \sin^2 \theta + 0 \\ &\quad - \rho^2 \sin^3 \varphi \sin^2 \theta - 0 - \rho^2 \sin \varphi \cos^2 \varphi \cos^2 \theta \\ &= -\rho^2 \sin^3 \varphi (\cos^2 \theta + \sin^2 \theta) - \rho^2 \sin \varphi \cos^2 \varphi (\sin^2 \theta + \cos^2 \theta) \\ &= -\rho^2 \sin^3 \varphi - \rho^2 \sin \varphi \cos^2 \varphi \\ &= -\rho^2 \sin \varphi (\sin^2 \varphi + \cos^2 \varphi) \\ &= -\rho^2 \sin \varphi \end{aligned}$$

Finally, dV becomes,

$$dV = \left| -\rho^2 \sin \varphi \right| d\rho d\theta d\varphi = \rho^2 \sin \varphi d\rho d\theta d\varphi$$

Recall that we restricted φ to the range $0 \leq \varphi \leq \pi$ for spherical coordinates and so we know that $\sin \varphi \geq 0$ and so we don't need the absolute value bars on the sine.

We will leave it to you to check the formula for dV for cylindrical coordinates if you'd like to. It is a much easier formula to check.

Surface Area

In this section we will look at the lone application (aside from the area and volume interpretations) of multiple integrals in this material. This is not the first time that we've looked at surface area. We first saw surface area in [Calculus II](#), however, in that setting we were looking at the surface area of a solid of revolution. In other words we were looking at the surface area of a solid obtained by rotating a function about the x or y axis. In this section we want to look at a much more general setting although you will note that the formula here is very similar to the formula we saw back in Calculus II.

Here we want to find the surface area of the surface given by $z = f(x, y)$ where (x, y) is a point from the region D in the xy -plane. In this case the surface area is given by,

$$S = \iint_D \sqrt{[f_x]^2 + [f_y]^2 + 1} dA$$

Let's take a look at a couple of examples.

Example 1 Find the surface area of the part of the plane $3x + 2y + z = 6$ that lies in the first octant.

Solution

Remember that the first octant is the portion of the xyz -axis system in which all three variables are positive. Let's first get a sketch of the part of the plane that we are interested in.

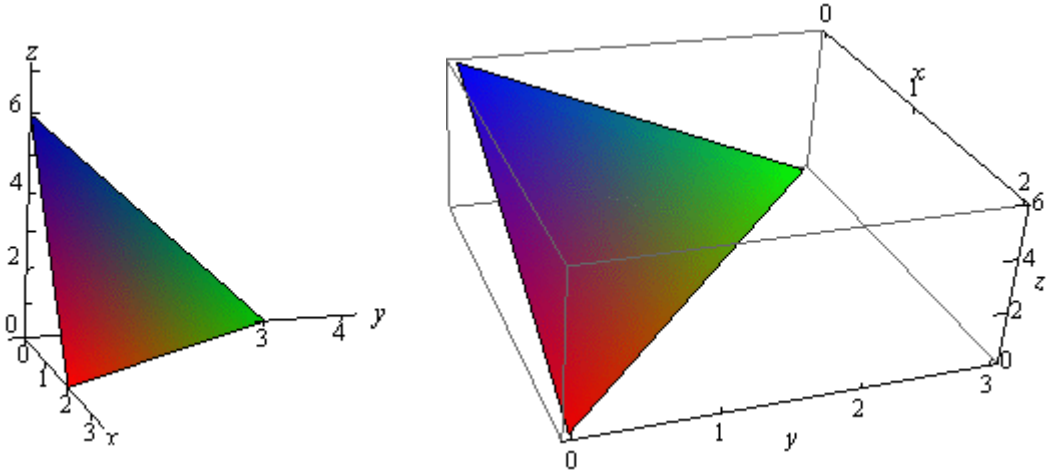

We'll also need a sketch of the region D .

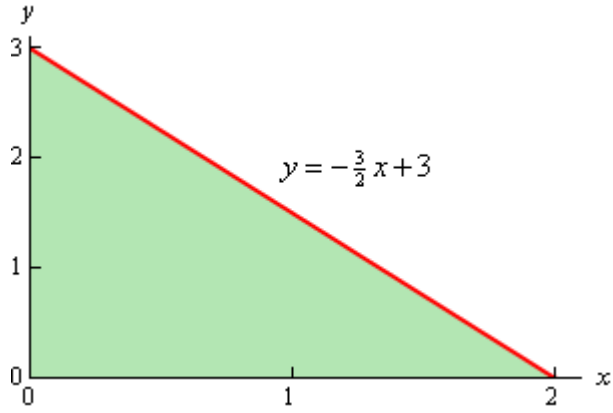

Remember that to get the region D we can pretend that we are standing directly over the plane and what we see is the region D . We can get the equation for the hypotenuse of the triangle by realizing that this is nothing more than the line where the plane intersects the xy -plane and we also know that $z = 0$ on the xy -plane. Plugging $z = 0$ into the equation of the plane will give us the equation for the hypotenuse.

Notice that in order to use the surface area formula we need to have the function in the form $z = f(x, y)$ and so solving for z and taking the partial derivatives gives,

$$z = 6 - 3x - 2y \qquad f_x = -3 \qquad f_y = -2$$

The limits defining D are,

$$0 \leq x \leq 2 \qquad 0 \leq y \leq -\frac{3}{2}x + 3$$

The surface area is then,

$$\begin{aligned} S &= \iint_D \sqrt{[-3]^2 + [-2]^2 + 1} \, dA \\ &= \int_0^2 \int_0^{-\frac{3}{2}x+3} \sqrt{14} \, dy \, dx \\ &= \sqrt{14} \int_0^2 -\frac{3}{2}x + 3 \, dx \\ &= \sqrt{14} \left(-\frac{3}{4}x^2 + 3x \right) \Big|_0^2 \\ &= 3\sqrt{14} \end{aligned}$$

Example 2 Determine the surface area of the part of $z = xy$ that lies in the cylinder given by $x^2 + y^2 = 1$.

Solution

In this case we are looking for the surface area of the part of $z = xy$ where (x, y) comes from the disk of radius 1 centered at the origin since that is the region that will lie inside the given

cylinder.

Here are the partial derivatives,

$$f_x = y \quad f_y = x$$

The integral for the surface area is,

$$S = \iint_D \sqrt{x^2 + y^2 + 1} \, dA$$

Given that D is a disk it makes sense to do this integral in polar coordinates.

$$\begin{aligned} S &= \iint_D \sqrt{x^2 + y^2 + 1} \, dA \\ &= \int_0^{2\pi} \int_0^1 r \sqrt{1+r^2} \, dr \, d\theta \\ &= \int_0^{2\pi} \frac{1}{2} \left(\frac{2}{3} \right) (1+r^2)^{\frac{3}{2}} \Big|_0^1 \, d\theta \\ &= \int_0^{2\pi} \frac{1}{3} \left(2^{\frac{3}{2}} - 1 \right) \, d\theta \\ &= \frac{2\pi}{3} \left(2^{\frac{3}{2}} - 1 \right) \end{aligned}$$

Area and Volume Revisited

This section is here only so we can summarize the geometric interpretations of the double and triple integrals that we saw in this chapter. Since the purpose of this section is to summarize these formulas we aren't going to be doing any examples in this section.

We'll first look at the area of a region. The area of the region D is given by,

$$\text{Area of } D = \iint_D dA$$

Now let's give the two volume formulas. First the volume of the region E is given by,

$$\text{Volume of } E = \iiint_E dV$$

Finally, if the region E can be defined as the region under the function $z = f(x, y)$ and above the region D in xy -plane then,

$$\text{Volume of } E = \iint_D f(x, y) dA$$

Note as well that there are similar formulas for the other planes. For instance, the volume of the region behind the function $y = f(x, z)$ and in front of the region D in the xz -plane is given by,

$$\text{Volume of } E = \iint_D f(x, z) dA$$

Likewise, the the volume of the region behind the function $x = f(y, z)$ and in front of the region D in the yz -plane is given by,

$$\text{Volume of } E = \iint_D f(y, z) dA$$

